

INDEX OF DOCUMENTS HELD ON THE PUBLIC REGISTER FOR PPL 127

1. 22 February 1999 Licence document dated 22 February 1999
Expiry: 21 February 2020

Interests in the Licence:

Santos Ltd	40.70
Delhi Petroleum Pty Ltd	20.21
Boral Energy Resources Ltd	13.19
Vamgas Pty Ltd	8.51
Gulf (Aust) Resources NL	4.75
Bridge Oil Developments Pty Ltd	3.99
Alliance Petroleum Australia Pty Ltd	3.97
Basin Oil NL	2.10
Reef Oil Pty Ltd	1.97
Santos Petroleum Pty Ltd	0.40
Santos (BOL) Pty Ltd	0.21
2. 22 February 1999 Memorandum entering licence on the public register and notating receipt of security.
3. 25 February 1999 Grant of Licence published in the South Australian Government Gazette dated 25 February 1999, Page 1166.
4. 10 December 1999 Certificate of Registration on Change of Name dated 6 October 1999:
From: Gulf (Aust) Resources NL
To: Novus Australia Resources NL
5. 10 December 1999 Memorandum entering change of company name on the Public Register.
6. 13 March 2000 Certificate of Registration on Change of Name dated 24 February 2000:
From: Boral Energy Resources
To: Origin Energy Resources Ltd
7. 13 March 2000 Memorandum entering change of company name on the Public Register.
8. 15 October 2002 Certificate of Registration on Change of Type and Conversion to a Proprietary Company dated 8 June 2000:
From: Basin Oil NL
To: Basin Oil Pty Ltd
9. 15 October 2002 Memorandum entering change of company name on the Public Register.
10. 7 May 2004 Memorandum dated 7 May 2004 entering notation of adoption of the register for PELs 5&6 as part of the Commercial Register.

11. 23 July 2004 Memorandum entering notation of registrable dealing on the public register:
 - DPPL Security dated 21 May 2004 between Delhi Petroleum Pty Ltd and Westpac Banking Corporation
Ref:SA 2004-44
12. 23 November 2005 Notation of discharge of security and receipt of replacement security is entered on the public register.
13. 13 January 2006 Certificate of Registration on Change of Name dated 29 June 2005:
From: Novus Australia Resources NL
To: Santos (NARNL Cooper) NL
14. 13 January 2006 Memorandum entering change of company name on the Public Register.
15. 9 May 2006 Certificate of Registration on Change of Name dated 1 December 2005:
From: Santos (NARNL Cooper) NL
To: Santos (NARNL Cooper) Pty Ltd.
16. 9 May 2006 Memorandum entering change of company name on the Public Register
17. 15 February 2011 Memorandum entering notation of the following registrable dealing on the public register.

Delhi Fixed and Floating Charge and Mortgage of JV Assets dated 29 September 2010 between Delhi Petroleum Pty Limited and Westpac Banking Corporation.
Ref: SA 2011-15
18. 28 June 2012 Memorandum entering notation of the following registrable dealing on the public register.

Royalty Deed dated 19 January 2012 between Delhi Petroleum Pty Ltd and Esso Australia Resources Pty Ltd.
Ref: SA 2012-42
19. 9 August 2017 Certificate of Registration on Change of Company Name dated 29 June 2017.

From: Origin Energy Resources Limited
To: Lattice Energy Limited
20. 9 August 2017 Memorandum entering notation of change of company name on the public register.

21. 7 June 2018 Memorandum entering notation of the following registrable dealing on the public register:
- Deed of Variation dated 4 December 2015 between Santos Limited, Santos Petroleum Pty Ltd, Vamgas Pty Ltd, Santos (NARNL Cooper) Pty Ltd, Santos (BOL) Pty Ltd, Reef Oil Pty Ltd, Bridge Oil Developments Pty Limited, Basin Oil Pty Ltd, Alliance Petroleum Australia Pty Ltd, Origin Energy Resources Limited and Delhi Petroleum Pty Ltd
Ref: SA 2018-18
22. 22 January 2020 Certificate of Registration on Change of Name dated 2 December 2019.
- From: Lattice Energy Limited
To: Beach Energy (Operations) Limited
23. 22 January 2020 Memorandum entering notation of change of company name on the public register.

**Petroleum and Geothermal Energy Act 2000
S.115**

MEMORANDUM

PETROLEUM PRODUCTION LICENCES

PPLs 6, 7, 8, 9, 10, 11, 12, 13, 14, 15, 16, 17, 18, 19, 20, 22, 23, 24, 25, 26, 27, 29, 30, 31, 32, 33, 35, 36, 37, 38, 39, 40, 41, 42, 43, 44, 45, 46, 47, 48, 51, 52, 53, 54, 55, 56, 57, 58, 59, 60, 61, 63, 64, 65, 66, 67, 68, 69, 70, 72, 73, 74, 75, 76, 77, 78, 79, 80, 81, 83, 84, 86, 87, 88, 89, 90, 91, 92, 94, 95, 98, 99, 100, 101, 102, 103, 104, 105, 106, 107, 108, 109, 110, 111, 113, 114, 115, 116, 117, 118, 119, 120, 121, 122, 123, 124, 125, 126, 127, 128, 129, 130, 131, 132, 133, 134, 135, 136, 137, 138, 139, 140, 143, 144, 145, 146, 147, 148, 149, 150, 151, 152, 153, 154, 155, 156, 158, 159, 160, 161, 162, 163, 164, 165, 166, 167, 172, 174, 175, 176, 177, 178, 179, 180, 182, 187, 189, 190, 193, 194, 195, 196, 201, 228, 229, 230, 231, 232, 233, 234, 235, 236, 237 and 238

ASSOCIATED ACTIVITIES LICENCES

AALs 258, 259 and 263

PIPELINE LICENCES

PLs 2, 5, 9, 15 and 20

1. Notation of change of company name:

From: Lattice Energy Limited
To: Beach Energy (Operations) Limited

is hereby entered on the public registers.



**BARRY A. GOLDSTEIN
Executive Director
Energy Resources Division
Department for Energy and Mining
Delegate of the Minister for Energy and Mining**

Date: 22 January 2020



Certificate of Registration on Change of Name

This is to certify that

LATTICE ENERGY LIMITED

Australian Company Number 007 845 338

did on the second day of December 2019 change its name to

BEACH ENERGY (OPERATIONS) LIMITED

Australian Company Number 007 845 338

The company is a public company.

The company is limited by shares.

The company is taken to be registered under the Corporations Act 2001 in South Australia and the date of commencement of registration is the ninth day of September, 1977.

Issued by the
Australian Securities and Investments Commission
on this second day of December 2019.

James Shipton
Chair

CERTIFICATE

Petroleum and Geothermal Energy Act 2000
S.115

MEMORANDUM

PETROLEUM PRODUCTION LICENCES

PPLs 6, 7, 8, 9, 10, 11, 12, 13, 14, 15, 16, 17, 18, 19, 20, 22, 23, 24, 25, 26, 27, 29, 30, 31, 32, 33, 35, 36, 37, 38, 39, 40, 41, 42, 43, 44, 45, 46, 47, 48, 51, 52, 53, 54, 55, 56, 57, 58, 59, 60, 61, 63, 64, 65, 66, 67, 68, 69, 70, 72, 73, 74, 75, 76, 77, 78, 79, 80, 81, 83, 84, 86, 87, 88, 89, 90, 91, 92, 94, 95, 98, 99, 100, 101, 102, 103, 104, 105, 106, 107, 108, 109, 110, 111, 113, 114, 115, 116, 117, 118, 119, 120, 121, 122, 123, 124, 125, 126, 127, 128, 129, 130, 131, 132, 133, 134, 135, 136, 137, 138, 139, 140, 143, 144, 145, 146, 147, 148, 149, 150, 151, 152, 153, 154, 155, 156, 158, 159, 160, 161, 162, 163, 164, 165, 166, 167, 172, 174, 175, 176, 177, 178, 179, 180, 182, 187, 189, 190, 193, 194, 195, 196, 201, 228, 229, 230, 231, 232, 233, 234, 235, 236, 237 and 238

PIPELINE LICENCES

PLs 5, 9 and 15

SA 2018-18 Notation of registrable dealing as evidenced by Deed of Variation dated 4 December 2015 between Santos Limited, Santos Petroleum Pty Ltd, Vamgas Pty Ltd, Santos (NARNL Cooper) Pty Ltd, Santos (BOL) Pty Ltd, Reef Oil Pty Ltd, Bridge Oil Developments Pty Limited, Basin Oil Pty Ltd, Alliance Petroleum Australia Pty Ltd, Origin Energy Resources Limited and Delhi Petroleum Pty Ltd is hereby entered on the public register.



BARRY A. GOLDSTEIN
Executive Director
Energy Resources Division
Department of the Premier and Cabinet
Delegate of the Minister for Energy and Mining

Date: 7 June 2018

Ref: 28/01/00045

Petroleum and Geothermal Energy Act 2000
S.115

MEMORANDUM

PETROLEUM RETENTION LICENCE
PRL 106

PETROLEUM EXPLORATION LICENCES
PELs 637 and 638

PETROLEUM PRODUCTION LICENCES
PPLs 6, 7, 8, 9, 10, 11, 12, 13, 14, 15, 16, 17, 18, 19, 20, 22, 23, 24, 25, 26, 27, 29, 30, 31, 32, 33, 35, 36, 37, 38, 39, 40, 41, 42, 43, 44, 45, 46, 47, 48, 51, 52, 53, 54, 55, 56, 57, 58, 59, 60, 61, 63, 64, 65, 66, 67, 68, 69, 70, 72, 73, 74, 75, 76, 77, 78, 79, 80, 81, 83, 84, 86, 87, 88, 89, 90, 91, 92, 94, 95, 98, 99, 100, 101, 102, 103, 104, 105, 106, 107, 108, 109, 110, 111, 113, 114, 115, 116, 117, 118, 119, 120, 121, 122, 123, 124, 125, 126, 127, 128, 129, 130, 131, 132, 133, 134, 135, 136, 137, 138, 139, 140, 143, 144, 145, 146, 147, 148, 149, 150, 151, 152, 153, 154, 155, 156, 158, 159, 160, 161, 162, 163, 164, 165, 166, 167, 172, 174, 175, 176, 177, 178, 179, 180, 182, 187, 189, 190, 193, 194, 195, 196, 201, 228, 229, 230, 231, 232, 233, 234, 235, 236, 237 and 238

PIPELINE LICENCES
PLs 2, 5, 9, 15 and 20

1. Notation of change of company name:

From: Origin Energy Resources Limited
To: Lattice Energy Limited

is hereby entered on the public registers.



BARRY A. GOLDSTEIN
Executive Director
Energy Resources Division
Department of the Premier and Cabinet
Delegate of the Minister for Mineral Resources and Energy

Date: 9 August 2017



Certificate of Registration on Change of Name

This is to certify that

ORIGIN ENERGY RESOURCES LIMITED

Australian Company Number 007 845 338

did on the twenty-ninth day of June 2017 change its name to

LATTICE ENERGY LIMITED

Australian Company Number 007 845 338

The company is a public company.

The company is limited by shares.

The company is taken to be registered under the Corporations Act 2001 in South Australia and the date of commencement of registration is the ninth day of September, 1977.

Issued by the
Australian Securities and Investments Commission
on this twenty-ninth day of June 2017.

Greg Medcraft
Chairman

CERTIFICATE

**Petroleum and Geothermal Energy Act 2000
S.115**

MEMORANDUM

PETROLEUM PRODUCTION LICENCES

PPLs 6, 7, 8, 9, 10, 11, 12, 13, 14, 15, 16, 17, 18, 19, 20, 22, 23, 24, 25, 26, 27, 29, 30, 31, 32, 33, 35, 36, 37, 38, 39, 40, 41, 42, 43, 44, 45, 46, 47, 48, 51, 52, 53, 54, 55, 56, 57, 58, 59, 60, 61, 63, 64, 65, 66, 67, 68, 69, 70, 72, 73, 74, 75, 76, 77, 78, 79, 80, 81, 83, 84, 86, 87, 88, 89, 90, 91, 92, 94, 95, 98, 99, 100, 101, 102, 103, 104, 105, 106, 107, 108, 109, 110, 111, 113, 114, 115, 116, 117, 118, 119, 120, 121, 122, 123, 124, 125, 126, 127, 128, 129, 130, 131, 132, 133, 134, 135, 136, 137, 138, 139, 140, 143, 144, 145, 146, 147, 148, 149, 150, 151, 152, 153, 154, 155, 156, 158, 159, 160, 161, 162, 163, 164, 165, 166, 167, 172, 174, 175, 176, 177, 178, 179, 180, 182, 187, 189, 190, 193, 194, 195, 196, 201, 228, 229, 230, 231, 232, 233, 234, 235, 236, 237 and 238

SA 2012-42 Notation of registrable dealing as evidenced by Royalty Deed dated 19 January 2012 between Delhi Petroleum Pty Ltd and Esso Australia Resources Pty Ltd is hereby entered on the public register.



**BARRY A. GOLDSTEIN
Executive Director
Energy Resources Division
Department for Manufacturing, Innovation, Trade, Resources and Energy
Delegate of the Minister for Mineral Resources and Energy**

Date: 28 June 2012

Ref: various files

Petroleum and Geothermal Energy Act 2000
S.115

MEMORANDUM

PETROLEUM PRODUCTION LICENCES

PPLs 6, 7, 8, 9, 10, 11, 12, 13, 14, 15, 16, 17, 18, 19, 20, 22, 23, 24, 25, 26, 27, 29, 30, 31, 32, 33, 35, 36, 37, 38, 39, 40, 41, 42, 43, 44, 45, 46, 47, 48, 51, 52, 53, 54, 55, 56, 57, 58, 59, 60, 61, 63, 64, 65, 66, 67, 68, 69, 70, 72, 73, 74, 75, 76, 77, 78, 79, 80, 81, 83, 84, 86, 87, 88, 89, 90, 91, 92, 94, 95, 98, 99, 100, 101, 102, 103, 104, 105, 106, 107, 108, 109, 110, 111, 113, 114, 115, 116, 117, 118, 119, 120, 121, 122, 123, 124, 125, 126, 127, 128, 129, 130, 131, 132, 133, 134, 135, 136, 137, 138, 139, 140, 143, 144, 145, 146, 147, 148, 149, 150, 151, 152, 153, 154, 155, 156, 158, 159, 160, 161, 162, 163, 164, 165, 166, 167, 172, 174, 175, 176, 177, 178, 179, 180, 182, 187, 189, 190, 193, 194, 195, 196, 201, 228, 229, 230, 231, 232, 233, 234, 235, 236, 237 and 238

and

PIPELINE LICENCES

PLs 2, 5, 9 and 15

SA 2011-15 Notation of registrable dealing as evidenced by Delhi Fixed and Floating Charge and Mortgage of JV Assets dated 29 September 2010 between Delhi Petroleum Pty Limited and Westpac Banking Corporation is hereby entered on the public register.



BARRY A. GOLDSTEIN
Director Petroleum and Geothermal
Minerals and Energy Resources
Primary Industries and Resources SA
Delegate of the Minister for Mineral Resources
Development

Date: 15 February 2011

Petroleum and Geothermal Energy Act 2000
S.115

MEMORANDUM

PETROLEUM PRODUCTION LICENCES

PPLs 6, 7, 8, 9, 10, 11, 12, 13, 14, 15, 16, 17, 18, 19, 20, 22, 23, 24, 25, 26, 27, 29, 30, 31, 32, 33, 35, 36, 37, 38, 39, 40, 41, 42, 43, 44, 45, 46, 47, 48, 51, 52, 53, 54, 55, 56, 57, 58, 59, 60, 61, 63, 64, 65, 66, 67, 68, 69, 70, 72, 73, 74, 75, 76, 77, 78, 79, 80, 81, 83, 84, 86, 87, 88, 89, 90, 91, 92, 94, 95, 98, 99, 100, 101, 102, 103, 104, 105, 106, 107, 108, 109, 110, 111, 113, 114, 115, 116, 117, 118, 119, 120, 121, 122, 123, 124, 125, 126, 127, 128, 129, 130, 131, 132, 133, 134, 135, 136, 137, 138, 139, 140, 143, 144, 145, 146, 147, 148, 149, 150, 151, 152, 153, 154, 155, 156, 158, 159, 160, 161, 162, 163, 164, 165, 166, 167, 172, 174, 175, 176, 177, 178, 179, 180, 182, 187, 189, 190, 193, 194, 195, 196, 201, 228, 229, 230, 231, 232, 233, 234, 235, 236, 237 and 238

and

PIPELINE LICENCES

PLs 2, 5, 9 and 15

SA 2011-15 Notation of registrable dealing as evidenced by Delhi Fixed and Floating Charge and Mortgage of JV Assets dated 29 September 2010 between Delhi Petroleum Pty Limited and Westpac Banking Corporation is hereby entered on the public register.



BARRY A. GOLDSTEIN
Director Petroleum and Geothermal
Minerals and Energy Resources
Primary Industries and Resources SA
Delegate of the Minister for Mineral Resources
Development

Date: 15 February 2011

Petroleum Act 2000
S.115

MEMORANDUM

Petroleum Production Licences (PPLs) 6, 7, 8, 9, 10, 11, 12, 13, 14, 15, 16, 17, 18, 19, 20, 22, 23, 24, 25, 26, 27, 28, 29, 30, 31, 32, 33, 34, 35, 36, 37, 38, 39, 40, 41, 42, 43, 44, 45, 46, 47, 48, 49, 50, 51, 52, 53, 54, 55, 56, 57, 58, 59, 60, 61, 63, 64, 65, 66, 67, 68, 69, 70, 71, 72, 73, 74, 75, 76, 77, 78, 79, 80, 81, 82, 83, 84, 85, 86, 87, 88, 89, 90, 91, 92, 93, 94, 95, 96, 97, 98, 99, 100, 101, 102, 103, 104, 105, 106, 107, 108, 109, 110, 111, 112, 113, 114, 115, 116, 117, 118, 119, 120, 121, 122, 123, 124, 125, 126, 127, 128, 129, 130, 131, 132, 133, 134, 135, 136, 137, 138, 139, 140, 141, 142, 143, 144, 145, 146, 147, 148, 149, 150, 151, 152, 153, 154, 155, 156, 157, 158, 159, 160, 161, 162, 163, 164, 165, 166, 167, 169, 170, 171, 172, 173, 174, 175, 176, 177, 178, 179, 180, 181, 182, 183, 184, 185, 186, 187, 188, 189, 190, 191, 192, 193, 194, 195, 196, 197, 198, 199 and Pipeline Licence (PL) 2.

1. Notation of change of company name –

From: Santos (NARNL Cooper) NL
To: Santos (NARNL Cooper) Pty Ltd

is hereby entered on the public register of licences.



C. D. COCKSHELL
A/Director Petroleum and Geothermal
Minerals and Energy Resources
Primary Industries and Resources SA
Delegate of the Minister for Mineral Resources
Development

Date: 9 May 2006

File: 27/2/4

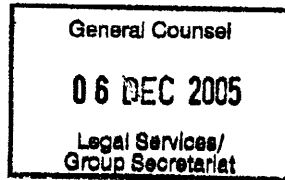

Form **242**

Santos Limited Attn: Graham Bollenhagen
GPO Box 2455
Adelaide SA 5001

Remove this top section if desired before framing

Certificate of Registration on Change of Type and Conversion to a Proprietary Company



This is to certify that

SANTOS (NARNL COOPER) NL

Australian Company Number 004 761 255

on the first day of December 2005 converted to
a company limited by shares
and on the first day of December 2005 changed to
a **proprietary** company.

The name of the company is now

SANTOS (NARNL COOPER) PTY LTD

Australian Company Number 004 761 255

The company is taken to be registered under the Corporations
Act 2001 in Victoria and the date of commencement of
registration is the twenty-first day of February, 1969.

Issued by the
Australian Securities and Investments Commission
on this first day of December, 2005.

A handwritten signature in black ink, appearing to read "Jeffrey Lucy".

Jeffrey Lucy
Chairman

CERTIFICATE

Petroleum Act 2000
S.115

MEMORANDUM

Petroleum Production Licences (PPLs) 6, 7, 8, 9, 10, 11, 12, 13, 14, 15, 16, 17, 18, 19, 20, 22, 23, 24, 25, 26, 27, 28, 29, 30, 31, 32, 33, 34, 35, 36, 37, 38, 39, 40, 41, 42, 43, 44, 45, 46, 47, 48, 49, 50, 51, 52, 53, 54, 55, 56, 57, 58, 59, 60, 61, 63, 64, 65, 66, 67, 68, 69, 70, 71, 72, 73, 74, 75, 76, 77, 78, 79, 80, 81, 82, 83, 84, 85, 86, 87, 88, 89, 90, 91, 92, 93, 94, 95, 96, 97, 98, 99, 100, 101, 102, 103, 104, 105, 106, 107, 108, 109, 110, 111, 112, 113, 114, 115, 116, 117, 118, 119, 120, 121, 122, 123, 124, 125, 126, 127, 128, 129, 130, 131, 132, 133, 134, 135, 136, 137, 138, 139, 140, 141, 142, 143, 144, 145, 146, 147, 148, 149, 150, 151, 152, 153, 154, 155, 156, 157, 158, 159, 160, 161, 162, 163, 164, 165, 166, 167, 169, 170, 171, 172, 173, 174, 175, 176, 177, 178, 179, 180, 181, 182, 183, 184, 185, 186, 187, 188, 189, 190, 191, 192, 193, 194, 195, 196, 197, 198, 199 and Pipeline Licence (PL) 2.

1. Notation of change of company name –

From: Novus Australia Resources NL
To: Santos (NARNL Cooper) NL

is hereby entered on the public register of licences.



BARRY A. GOLDSTEIN
Director Petroleum
Minerals and Energy Resources
Primary Industries and Resources SA
Delegate of the Minister for Mineral Resources
Development

Date: 13 January 2006

File: 27/2/4

Santos Limited Attn: Graham Bollenhagen
GPO Box 2455
Adelaide SA 5001

Remove this top section if desired before framing

Certificate of Registration on Change of Name



This is to certify that

NOVUS AUSTRALIA RESOURCES NL

Australian Company Number 004 761 255

did on the twenty-ninth day of June 2005 change its name to

SANTOS (NARNL COOPER) NL

Australian Company Number 004 761 255

The company is a public company.

The company is a no liability company.

The company is taken to be registered under the Corporations Act 2001 in Victoria and the date of commencement of registration is the twenty-first day of February, 1969.

Issued by the
Australian Securities and Investments Commission
on this twenty-ninth day of June, 2005.

Jeffrey Lucy
Chairman

CERTIFICATE

Petroleum Act 2000
S.115

MEMORANDUM

PETROLEUM PRODUCTION LICENCES (PPLs) 6, 7, 8, 9, 10, 11, 12, 13, 14, 15, 16, 17, 18, 19, 20, 22, 23, 24, 25, 26, 27, 28, 29, 30, 31, 32, 33, 34, 35, 36, 37, 38, 39, 40, 41, 42, 43, 44, 45, 46, 47, 48, 49, 50, 51, 52, 53, 54, 55, 56, 57, 58, 59, 60, 61, 63, 64, 65, 66, 67, 68, 69, 70, 71, 72, 73, 74, 75, 76, 77, 78, 79, 80, 81, 82, 83, 84, 85, 86, 87, 88, 89, 90, 91, 92, 93, 94, 95, 96, 97, 98, 99, 100, 101, 102, 103, 104, 105, 106, 107, 108, 109, 110, 111, 113, 114, 115, 116, 117, 118, 119, 120, 121, 122, 123, 124, 125, 126, 127, 128, 129, 130, 131, 132, 133, 134, 135, 136, 137, 138, 139, 140, 141, 142, 143, 144, 145, 146, 147, 148, 149, 150, 151, 152, 153, 154, 155, 156, 157, 158, 159, 160, 161, 162, 163, 164, 165, 166, 167, 169, 170, 171, 172, 173, 174, 175, 176, 177, 178, 179, 180, 181, 182, 183, 184, 185, 186, 187, 188, 189, 190, 191, 192, 193, 194, 195, 196, 197, 198, 199

and

PIPELINE LICENCES (PLs) 2, 5, 9 and 15

1. Notation of receipt of Bank Guarantee dated 27 October 2005, is hereby entered on the commercial register.
2. Security is held to cover any event occurring in any licence operated by Santos Limited on behalf of the respective Cooper Basin Joint Ventures in South Australia.
3. Cash security held in respect of PPL 152 is hereby discharged to Santos Limited.
4. Bank Guarantees held in respect of the above referenced PLs and PPLs (excluding PPL 152) are hereby discharged to Santos Limited.



BARRY A GOLDSTEIN
Director Petroleum
Minerals and Energy Division
Primary Industries and Resources SA
Delegate of the Minister for Mineral Resources
Development

Date: 23 November 2005

Petroleum Act 2000

S.115

MEMORANDUM

PETROLEUM PRODUCTION LICENCES 6, 7, 8, 9, 10, 11, 12, 13, 14, 15, 16, 17, 18, 19, 20, 22, 23, 24, 25, 26, 27, 28, 29, 30, 31, 32, 33, 34, 35, 36, 37, 38, 39, 40, 41, 42, 43, 44, 45, 46, 47, 48, 49, 50, 51, 52, 53, 54, 55, 56, 57, 58, 59, 60, 61, 63, 64, 65, 66, 67, 68, 69, 70, 71, 72, 73, 74, 75, 76, 77, 78, 79, 80, 81, 82, 83, 84, 85, 86, 87, 88, 89, 90, 91, 92, 93, 94, 95, 96, 97, 98, 99, 100, 101, 102, 103, 104, 105, 106, 107, 108, 109, 110, 111, 113, 114, 115, 116, 117, 118, 119, 120, 121, 122, 123, 124, 125, 126, 127, 128, 129, 130, 131, 132, 133, 134, 135, 136, 137, 138, 139, 140, 141, 142, 143, 144, 145, 146, 147, 148, 149, 150, 151, 152, 153, 154, 155, 156, 157, 158, 159, 160, 161, 162, 163, 164, 165, 166, 167, 169, 170, 171, 172, 173, 174, 175, 176, 177, 178, 179, 180, 181, 182, 183, 184, 185, 186, 187, 188, 189, 190, 191, 192, 193, 194, 195, 196, 197, 198, 199

PIPELINE LICENCES 2, 5, 9 AND 15

1. Notation of registrable dealing as evidenced by the following document is hereby entered on the Public Register;

- SA 2004-44 DPPL Security dated 21 May 2004 between Delhi Petroleum Pty Ltd and Westpac Banking Corporation.



Paul Holloway

Leader of the Government in the Legislative Council
Minister for Industry, Trade and Regional Development
Minister for Mineral Resources Development
Minister for Small Business

Date: 23/7/04

Petroleum Act 2000

S.115(2)(e)

S.117(2)(b)

MEMORANDUM

PETROLEUM PRODUCTION LICENCES (PPLs) 6, 7, 8, 9, 10, 11, 12, 13, 14, 15, 16, 17, 18, 19, 20, 22, 23, 24, 25, 26, 27, 28, 29, 30, 31, 32, 33, 34, 35, 36, 37, 38, 39, 40, 41, 42, 43, 44, 45, 46, 47, 48, 49, 50, 51, 52, 53, 54, 55, 56, 57, 58, 59, 60, 61, 63, 64, 65, 66, 67, 68, 69, 70, 71, 72, 73, 74, 75, 76, 77, 78, 79, 80, 81, 82, 83, 84, 85, 86, 87, 88, 89, 90, 91, 92, 93, 94, 95, 96, 97, 98, 99, 100, 101, 102, 103, 104, 105, 106, 107, 108, 109, 110, 111, 112, 113, 114, 115, 116, 117, 118, 119, 120, 121, 122, 123, 124, 125, 126, 127, 128, 129, 130, 131, 132, 133, 134, 135, 136, 137, 138, 139, 140, 141, 142, 143, 144, 145, 146, 147, 148, 149, 150, 151, 152, 153, 154, 155, 156, 157, 158, 159, 160, 161, 162, 163, 164, 165, 166, 167, 169, 170, 171, 172, 173, 174, 175, 176, 177, 178, 179, 180, 181, 182, 183, 184, 185, 186, 187, 188, 189, 190, 191, 192, 193, 194, 195, 196, 197, 198 and 199

- 1 Pursuant to sections 115(2)(e) and 117(2)(b) of the *Petroleum Act 2000*, notation is hereby entered on the public and commercial register for each of the abovementioned PPLs, that the register created under the then *Petroleum Act 1940*, relative to Petroleum Exploration Licences 5 and 6, which expired on 27 February 1999, is adopted as part of the commercial register for each of the above said PPLs

Dated: 7 May 2004



**T. AUST
A/Director Petroleum
Minerals and Energy Division
Primary Industries and Resources SA
Delegate of the Minister for Mineral
Resources Development**

Petroleum Act 2000
S.115

MEMORANDUM

PETROLEUM PRODUCTION LICENCES

PPL's 6, 7, 8, 9, 10, 11, 12, 13, 14, 15, 16, 17, 18, 19, 20, 22, 23, 24, 25, 27, 28, 29, 30, 31, 32, 33, 34, 35, 36, 37, 38, 39, 40, 41, 42, 43, 44, 45, 46, 47, 48, 49, 50, 51, 52, 53, 54, 55, 56, 57, 58, 59, 60, 61, 63, 64, 65, 66, 67, 68, 69, 70, 71, 72, 73, 74, 75, 78, 79, 80, 81, 82, 83, 84, 85, 86, 87, 88, 89, 90, 91, 92, 93, 94, 95, 96, 97, 98, 99, 100, 101, 102, 103, 104, 105, 106, 107, 108, 109, 110, 111, 112, 113, 114, 115, 116, 117, 119, 120, 124, 126, 127, 128, 129, 130, 132, 133, 134, 135, 137, 138, 139, 140, 141, 143, 144, 145, 146, 148, 149, 150, 151, 153, 154, 155, 157, 159, 160, 161, 162, 163, 164, 165, 166, 169, 170, 171, 172, 173, 174, 175, 176, 177, 178, 179, 180, 181, 183, 184, 185, 186, 188, 189, 190, 192, 193, 195, 196, 198, 199;

And

PIPELINE LICENCE
PL 2

1. Notation of change of company name –

From: Basin Oil NL
To: Basin Oil Pty Ltd

is hereby entered on the public register of licences.

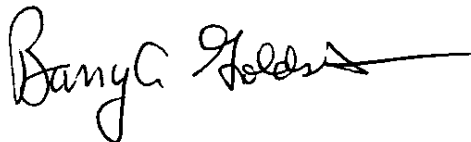

BARRY A GOLDSTEIN
Director Petroleum
Office of Minerals and Energy Resources
Delegate of the Minister for Mineral Resources
Development

Date: 15 October 2002

Form 242

FREEHILL HOLLINGDALE & PAGE
AMP BUILDING
22nd Fl
140 ST Georges Terrace
PERTH WA 6000

Remove this top section if desired before framing

Certificate of Registration on Change of Type and Conversion to a Proprietary Company



This is to certify that

BASIN OIL N.L.

Australian Company Number 000 628 017

on the eighth day of June 2000 converted to
a company limited by shares
and on the eighth day of June 2000 changed
to a proprietary company.

The name of the company is now

BASIN OIL PTY LTD

Australian Company Number 000 628 017

The company is taken to be registered as a company
under the Corporations Law of New South Wales.

CERTIFICATE

Issued by the
Australian Securities and Investments Commission
on this eighth day of June, 2000.

Alan Cameron
Chairman

MEMORANDUM

PETROLEUM ACT 1940

SECTION 44

**PETROLEUM EXPLORATION LICENCES NOS. 27, 32, 57, 66 AND 72
PETROLEUM PRODUCTION LICENCES NOS. 6 TO 20, 22 TO 61 AND 63 TO 168
PIPELINE LICENCES 2, 5, 9 AND 10**

Receipt of the following document is hereby entered onto the Petroleum Register.

- Certificate of Registration on Change of Name dated 24 February 2000.
Boral Energy Resources Ltd is now known as Origin Energy Resources Ltd.



**J S ZABROWARNY
MANAGER PETROLEUM LICENSING AND ROYALTIES**

13 March 2000

24/02/00 14:37

+61 8 8223 4405

User: MARKK
Host: BETA1.oqa.boral.com.au
Class: Job: MARKK_TRLRP



CLAYTON UTZ
1 O'Connell Street
SYDNEY NSW 2000

Remove this top section if desired before printing

Certificate of Registration on Change of Name



This is to certify that

BORAL ENERGY RESOURCES LIMITED

Australian Company Number 007 845 338

did on the twenty-fourth day of February 2000 change its name to

ORIGIN ENERGY RESOURCES LIMITED

Australian Company Number 007 845 338

The company is a public company.

The company is limited by shares.

The company is taken to be registered as a company
under the Corporations Law of South Australia.

CERTIFICATE

Issued by the
Australian Securities and Investments Commission
on this twenty-fourth day of February, 2000.

Alan Cameron
Chairman

MEMORANDUM

Section 44, Petroleum Act 1940

PETROLEUM PRODUCTION LICENCES 6 to 20,
22 to 61, 63 to 140, 142 to 167

PIPELINE LICENCE No. 2

Receipt of the following document is hereby entered onto the Petroleum Register.

- Certificate of Registration on Change of Name dated 6 October 1999.
Gulf (Aust) Resources NL is now known as Novus Australia Resources NL.



J S Zabrowarny
Manager, Petroleum Licensing and Royalties

10 December 1999



502 0180 004

NOVUS PETROLEUM LIMITED
Level 9
321 Kent Street
SYDNEY NSW 2000

Remove this top section if desired before framing

Certificate of Registration on Change of Name

This is to certify that

GULF (AUST) RESOURCES N.L.

Australian Company Number 004 761 255

did on the sixth day of October 1999 change its name to

NOVUS AUSTRALIA RESOURCES NL

Australian Company Number 004 761 255

The company is a public company.

The company is a no liability company.

The company is taken to be registered as a company
under the Corporations Law of Victoria.



CERTIFICATE

Issued by the
Australian Securities and Investments Commission
on this sixth day of October, 1999.

Alan Cameron
Chairman

GRANT OF PETROLEUM PRODUCTION LICENCE

Department of Primary Industries and Resources, 22 February 1999

NOTICE is hereby given that pursuant to delegated powers dated 20 November 1997, *Gazetted* 4 December 1997, page 1526, the undermentioned Petroleum Production Licence has been granted under the provisions of the Petroleum Act 1940.

D. R. MUTTON, Chief Executive, Delegate of the Minister for Primary Industries, Natural Resources and Regional Development

No. of Licence	Licensees	Locality	Date of Expiry	Area in km ²	Reference
127	Santos Ltd Delhi Petroleum Pty Ltd Boral Energy Resources Ltd Vamgas Pty Ltd Gulf (Aust) Resources NL Alliance Petroleum Australia Pty Ltd Reef Oil Pty Ltd Santos Petroleum Pty Ltd Bridge Oil Developments Pty Ltd Santos (BOL) Pty Ltd Basin Oil NL	Nulla Field in the Cooper Basin of South Australia	21 February 2020	4.24	SR.28.1.260

Description of the Area

All that part of the State of South Australia bounded as follows: commencing at a point being the intersection of latitude 27°46'30"S and longitude 139°42'40"E, thence east to longitude 139°43'15"E, south to latitude 27°46'35"S, east to longitude 139°43'20"E, south to latitude 27°46'40"S, east to longitude 139°43'30"E, south to latitude 27°48'05"S, west to longitude 139°43'25"E, south to latitude 27°48'10"S, west to longitude 139°43'10"E, north to latitude 27°48'00"S, west to longitude 139°43'00"E, north to latitude 27°47'40"S, west to longitude 139°42'50"E, north to latitude 27°47'20"S, west to longitude 139°42'10"E, north to latitude 27°46'50"S, east to longitude 139°42'20"E, north to latitude 27°46'40"S, east to longitude 139°42'40"E, and north to the point of commencement, all the within latitudes and longitudes being geodetic and expressed in terms of the Australian Geodetic Datum as defined on p. 4984 of *Commonwealth Gazette* number 84 dated 6 October 1966.

Area 4.24 km² approximately.

GRANT OF PETROLEUM PRODUCTION LICENCE

Department of Primary Industries and Resources, 22 February 1999

NOTICE is hereby given that pursuant to delegated powers dated 20 November 1997, *Gazetted* 4 December 1997, page 1526, the undermentioned Petroleum Production Licence has been granted under the provisions of the Petroleum Act 1940.

D. R. MUTTON, Chief Executive, Delegate of the Minister for Primary Industries, Natural Resources and Regional Development

No. of Licence	Licensees	Locality	Date of Expiry	Area in km ²	Reference
128	Santos Ltd Delhi Petroleum Pty Ltd Boral Energy Resources Ltd Vamgas Pty Ltd Gulf (Aust) Resources NL Alliance Petroleum Australia Pty Ltd Reef Oil Pty Ltd Santos Petroleum Pty Ltd Bridge Oil Developments Pty Ltd Santos (BOL) Pty Ltd Basin Oil NL	Garanjanie (West) Field in the Cooper Basin of South Australia	21 February 2020	0.29	SR.28.1.287

Description of the Area

All that part of the State of South Australia bounded as follows: commencing at a point being the intersection of latitude 28°31'15"S and longitude 140°03'45"E, thence east to longitude 140°03'50"E, south to latitude 28°31'40"S, west to longitude 140°03'25"E, north to latitude 28°31'35"S, east to longitude 140°03'30"E, north to latitude 28°31'30"S, east to longitude 140°03'35"E, north to latitude 28°31'25"S, east to longitude 140°03'40"E, north to latitude 28°31'20"S, east to longitude 140°03'45"E and north to the point of commencement, all the within latitudes and longitudes being geodetic and expressed in terms of the Australian Geodetic Datum as defined on p. 4984 of *Commonwealth Gazette* number 84 dated 6 October 1966.

Area 0.29 km² approximately.

MEMORANDUM

PETROLEUM PRODUCTION LICENCE NO. 127

1. This licence granted on 22/2/99 is hereby entered on the Petroleum Register.
2. A security in the form of a \$15,000 bank guarantee has been lodged with respect to this licence.
3. Interests in the licence are as follows:

	%
• Santos Ltd	40.70
• Delhi Petroleum Pty Ltd	20.21
• Boral Energy Resources Ltd	13.19
• Vamgas Pty Ltd	8.51
• Gulf (Aust) Resources NL	4.75
• Bridge Oil Developments Pty Ltd	3.99
• Alliance Petroleum Australia Pty Ltd	3.97
• Basin Oil NL	2.10
• Reef Oil Pty Ltd	1.97
• Santos Petroleum Pty Ltd	0.40
• Santos (BOL) Pty Ltd	0.21

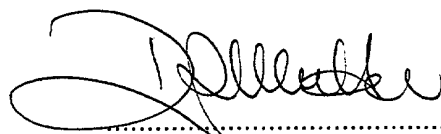

.....
D R Mutton
**CHIEF EXECUTIVE
DEPT OF PRIMARY INDUSTRIES
AND RESOURCES**

Delegate of the Minister for Primary
Industries, Natural Resources and
Regional Development

**SOUTH AUSTRALIA
PETROLEUM ACT 1940**

PETROLEUM PRODUCTION LICENCE NO.127

I, **DENNIS RAY MUTTON**, Chief Executive, Department of Primary Industries and Resources (CE) in the State of South Australia pursuant to the provisions of the Petroleum Act, 1940 and all other enabling powers for and on behalf of Robert Gerard Kerin, Minister for Primary Industries, Natural Resources and Regional Development (Minister), pursuant to delegation dated 20 November 1997, (refer Government Gazette dated 4 December 1997 page 1526), **HEREBY GRANT TO :-**

- **ALLIANCE PETROLEUM AUSTRALIA PTY LTD**, A.C.N. 004 559 951 of Level 29, 91 King William Street, Adelaide, South Australia,
- **BASIN OIL N.L.** A.C.N. 000 628 017 of Level 4, 828 Pacific Highway, Gordon, New South Wales.
- **BORAL ENERGY RESOURCES LIMITED**, ACN 007 845 338 of 60 Hindmarsh Square, Adelaide, South Australia,
- **BRIDGE OIL DEVELOPMENTS PTY LTD.** A.C.N. 001 152 049 of Level 29, 91 King William Street, Adelaide, South Australia,
- **DELHI PETROLEUM PTY LTD**, ACN 007 854 686 of c/- Esso Australia Ltd., Esso House, 12 Riverside Quay, Southbank, Victoria,
- **GULF (AUST) RESOURCES NO LIABILITY**, ACN 004 761 255 of Level 14, London House, 216 St George's Terrace, Perth, Western Australia,
- **REEF OIL PTY LTD**, A.C.N. 000 646 800 of Level 29, 91 King William Street, Adelaide, South Australia,
- **SANTOS LIMITED**, ACN 007 550 923 of Level 29, 91 King William Street, Adelaide, South Australia,
- **SANTOS (BOL) PTY LTD** A.C.N. 000 670 575 of Level 29, 91 King William Street, Adelaide, South Australia,

COMMISSIONER OF STATE TAXATION

S.A. STAMP DUTY PAID
ORIGINAL SET OF 17 COPIES
23/02/99 14:15:46 FLS319.1
DEED

#10.00

- **SANTOS PETROLEUM PTY LTD**, A.C.N. 000 146 369 of Level 29, 91 King William Street, Adelaide, South Australia, and
- **VAMGAS PTY LTD**, ACN 006 245 110 of Level 29, 91 King William Street, Adelaide, South Australia.

(hereinafter referred to as 'the Licensees') a Petroleum Production Licence in respect of the area described below and subject to the conditions set out below, to have effect for a period of twenty-one (21) years to expire on the 21st day of February 2020 but carrying the rights of renewal conferred by the Petroleum Act 1940.

DESCRIPTION OF THE AREA

The land comprised in this licence is that part of the State of South Australia described in the Schedule hereto.

CONDITIONS

The Licensees shall at all times comply with:

- the provisions of the Petroleum Act 1940 and of any regulations for the time being and from time to time in force under that Act; and
- all directions given to them under the Act or regulations for the time being and from time to time in force under that Act.

DECLARATION

It is hereby acknowledged and agreed that the licensees, as at the date of grant of this licence, own and hold the following undivided interests respectively in and under this licence:-

Santos	:	Forty point seven per centum	(40.7%)
Delhi	:	Twenty point two one per centum	(20.21%)
Boral	:	Thirteen point one nine per centum	(13.19%)
Vamgas	:	Eight point five one per centum	(8.51%)
Gulf	:	Four point seven five per centum	(4.75%)
Bridge Oil Dev.	:	Three point nine nine per centum	(3.99%)
Alliance	:	Three point nine seven per centum	(3.97%)

Basin	:	Two point one per centum	(2.1%)
Reef	:	One point nine seven per centum	(1.97%)
Santos Petroleum	:	Zero point four per centum	(0.4%)
Santos (BOL)	:	Zero point two one per centum	(0.21%)

and that as between the Licensees the undivided interests so owned and held by the Licensees shall be subject to the provisions of a Joint Operating Agreement dated the 20th day of February 1974 to which the Licensees are parties and as the same has been amended and as may hereafter be amended or replaced from time to time **PROVIDED THAT** any amendment or replacement which affects or could affect the undivided interests of the Licensees shall be of no force or effect unless approved by the Minister.

Signed by the Chief Executive,
Department of Primary Industries and Resources at Adelaide

this 22nd day of February 1999

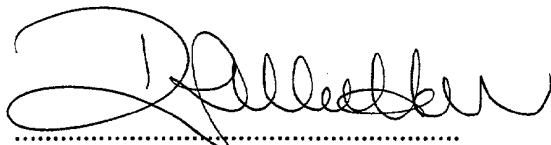

.....
Dennis Ray Mutton
Chief Executive
Department of Primary Industries and Resources
Delegate of the Minister for Primary Industries
Natural Resources and Regional Development

SIGNED, SEALED AND DELIVERED)

by the said **LICENSEES** at *Adelaide*)
this *16th* day of *February* 1999)

Executed on behalf of)
ALLIANCE PETROLEUM AUSTRALIA)
PTY LTD, BRIDGE OIL DEVELOPMENTS)
PTY LTD, REEF OIL PTY LTD, SANTOS)
LIMITED, SANTOS (BOL) PTY LTD, SANTOS)
PETROLEUM PTY LTD and VAMGAS PTY LTD)
respectively by being **SIGNED, SEALED AND**)
DELIVERED by its duly authorised Attorney under)
Power of Attorney who hereby states that he has)
received no notice of revocation of the Power of)
Attorney effecting such appointment, in the)
presence of:)

John

Alan

Witness

THE COMMON SEAL of)
BASIN OIL NL was hereunto affixed)
in the presence of:)



Donald Beard
.....
Director **Donald Beard**
Managing Director

S. Russotti
.....
Secretary **S. Russotti**
Company Secretary

THE COMMON SEAL of)
BORAL ENERGY RESOURCES was hereunto)
affixed in the presence of:)

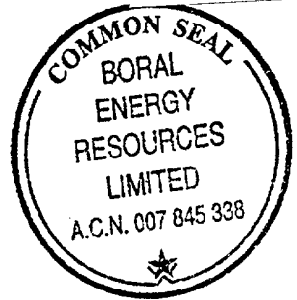

.....
Director

.....
Secretary

~~SIGNED, SEALED AND DELIVERED~~ *)
for and on behalf of DELHI PETROLEUM)
PTY LTD by IAN WILLIAM ANGUS)
its duly authorised Attorney under Power of)
Attorney dated the 12th day of February)
1993, who hereby states that he has no notice)
of revocation of the said Power of Attorney at)
the time of executing this instrument in the)
presence of:)

.....
Witness

.....
Delhi Petroleum Pty Ltd
by its Attorney
IAN WILLIAM ANGUS

THE COMMON SEAL of)
GULF (AUST) RESOURCES NL was hereunto)
affixed in the presence of:)



.....
Director
DAVID R. WHITBY
MANAGING DIRECTOR

.....
Secretary

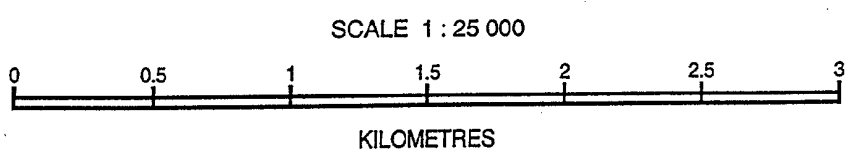
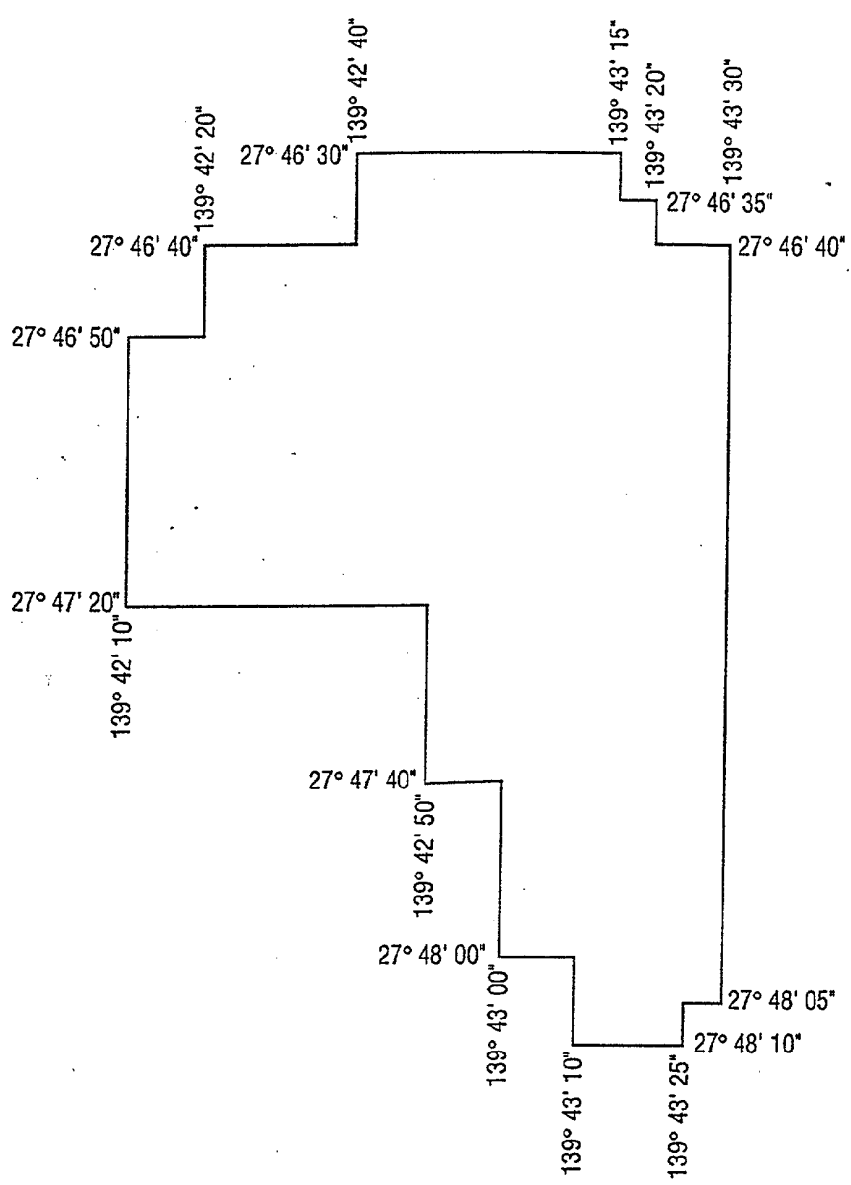

All the within latitudes and longitudes are geodetic and expressed in terms of the Australian Geodetic Datum as defined on page 4984 of Commonwealth Gazette number 84 dated 6 October 1966, except those latitudes and longitudes underlined which are expressed in terms of Clarke 1858 Spheroid (Transverse Mercator Projection)

**SANTOS LTD. DELHI PETROLEUM PTY. LTD. BORAL ENERGY RESOURCES LTD.
 VAMGAS PTY. LTD. GULF (AUST) RESOURCES N.L. BASIN OIL N.L. REEF OIL PTY. LTD.
 ALLIANCE PETROLEUM AUSTRALIA PTY. LTD. BRIDGE OIL DEVELOPMENTS PTY. LTD.
 SANTOS PETROLEUM PTY. LTD. SANTOS (BOL) PTY. LTD.**

**NULLA FIELD
 PETROLEUM PRODUCTION LICENCE NO. 127**

SCHEDULE

PETROLEUM PRODUCTION LICENCE NO. 127

DESCRIPTION OF AREA

All that part of the State of South Australia, bounded as follows:-

Commencing at a point being the intersection of latitude $27^{\circ} 46' 30''$ S and longitude $139^{\circ} 42' 40''$ E, thence east to longitude $139^{\circ} 43' 15''$ E, south to latitude $27^{\circ} 46' 35''$ S, east to longitude $139^{\circ} 43' 20''$ E, south to latitude $27^{\circ} 46' 40''$ S, east to longitude $139^{\circ} 43' 30''$ E, south to latitude $27^{\circ} 48' 05''$ S, west to longitude $139^{\circ} 43' 25''$ E, south to latitude $27^{\circ} 48' 10''$ S, west to longitude $139^{\circ} 43' 10''$ E, north to latitude $27^{\circ} 48' 00''$ S west to longitude $139^{\circ} 43' 00''$ E, north to latitude $27^{\circ} 47' 40''$ S, west to longitude $139^{\circ} 42' 50''$ E, north to latitude $27^{\circ} 47' 20''$ S, west to longitude $139^{\circ} 42' 10''$ E, north to latitude $27^{\circ} 46' 50''$ S, east to longitude $139^{\circ} 42' 20''$ E, north to latitude $27^{\circ} 46' 40''$ S, east to longitude $139^{\circ} 42' 40''$ E, and north to the point of commencement.

All within latitudes and longitudes are geodetic and expressed in terms of the Australian Geodetic Datum as defined on p.4984 of Commonwealth Gazette Number 84 dated 6 October 1966.

AREA 4.24 square kilometres approximately.

In accordance with Section 117 of the *Petroleum Act 2000* (Act) this document forms part of 'The Commercial Register'.

Section 118 of the Act provides for the following:

Authority to search register

(1) A person is entitled to have access to the material included in the commercial register, on payment of the prescribed inspection fee, if the access is authorised by—

- (a) a person who has a legal or equitable interest in the relevant licence or registered dealing; or
- (b) (b) the Minister.

(2) The Minister must not authorise access under subsection (1)(b) unless the Minister has consulted with the licensee to whom the material relates and is satisfied that access should be authorised in the public interest.

FOR FURTHER INFORMATION PLEASE CONTACT:

Department of State Development
Energy Resources Division
GPO Box 320,
Adelaide SA 5001
(08) 8463 3204