

INDEX OF DOCUMENTS HELD ON THE PUBLIC REGISTER FOR PPL 139

1. 10 June 1999 Grant of Licence
Effective: 1 January 1999
Expiry Date: 31 December 2019
2. 10 June 1999 Memorandum entering Petroleum Production Licence
PPL 139 on the petroleum register

Interests in the Licence are as follows:

	%
Santos Ltd	40.70
Delhi Petroleum Pty Ltd	20.21
Boral Energy Resources Ltd	13.19
Vamgas Pty Ltd	8.51
Gulf (Aust) Resources NL	4.75
Bridge Oil Developments Pty Ltd	3.99
Alliance Petroleum Australia Pty Ltd	3.97
Basin Oil NL	2.10
Reef Oil Pty Ltd	1.97
Santos Petroleum Pty Ltd	0.40
Santos (BOL) Pty Ltd	0.21
3. 17 June 1999 Gazettal of grant of PPL 139 published in SA Government
Gazette dated 17 June 1999, Page 3119.
4. 10 December 1999 Certificate of Registration on Change of Name dated 6
October 1999:
From: Gulf (Aust) Resources NL
To: Novus Australia Resources NL
5. 10 December 1999 Memorandum entering change of company name on the
Public Register
6. 13 March 2000 Certificate of Registration on Change of Name dated 24
February 2000:
From: Boral Energy Resources
To: Origin Energy Resources Ltd
7. 13 March 2000 Memorandum entering change of company name on the
Public Register.
8. 15 October 2002 Certificate of Registration on Change of Type and
Conversion to a Proprietary Company dated 8 June
2000:
From: Basin Oil NL
To: Basin Oil Pty Ltd
9. 15 October 2002 Memorandum entering change of company name on the
Public Register.

10. 7 May 2004 Memorandum dated 7 May 2004 entering notation of adoption of the register for PELs 5&6 as part of the Commercial Register.
11. 23 July 2004 Memorandum entering notation of registrable dealing on the public register:
- DPPL Security dated 21 May 2004 between Delhi Petroleum Pty Ltd and Westpac Banking Corporation Ref:SA 2004-44
12. 23 November 2005 Notation of discharge of security and receipt of replacement security is entered on the public register.
13. 13 January 2006 Memorandum entering change of name on the public register:
- From: Novus Australia Resources NL
To: Santos (NARNL Cooper) NL
14. 9 May 2006 Memorandum entering change of name on the public register:
- From: Santos (NARNL Cooper) NL
To: Santos (NARNL Cooper) Pty Ltd
15. 15 February 2011 Memorandum entering notation of the following registrable dealing on the public register.
- Delhi Fixed and Floating Charge and Mortgage of JV Assets dated 29 September 2010 between Delhi Petroleum Pty Limited and Westpac Banking Corporation.
Ref: SA 2011-15
16. 28 June 2012 Memorandum entering notation of the following registrable dealing on the public register.
- Royalty Deed dated 19 January 2012 between Delhi Petroleum Pty Ltd and Esso Australia Resources Pty Ltd.
Ref: SA 2012-42
17. 9 August 2017 Certificate of Registration on Change of Name dated 29 June 2017
- From: Origin Energy Resources Limited
To: Lattice Energy Limited
18. 9 August 2017 Memorandum entering change of name on the public register

19. 7 June 2018 Memorandum entering notation of the following registrable dealing on the public register:
- Deed of Variation dated 4 December 2015 between Santos Limited, Santos Petroleum Pty Ltd, Vamgas Pty Ltd, Santos (NARNL Cooper) Pty Ltd, Santos (BOL) Pty Ltd, Reef Oil Pty Ltd, Bridge Oil Developments Pty Limited, Basin Oil Pty Ltd, Alliance Petroleum Australia Pty Ltd, Origin Energy Resources Limited and Delhi Petroleum Pty Ltd
Ref: SA 2018-18
20. 22 January 2020 Certificate of Registration on Change of Name dated 2 December 2019.
- From: Lattice Energy Limited
To: Beach Energy (Operations) Limited
21. 22 January 2020 Memorandum entering notation of change of company name on the public register.

**Petroleum and Geothermal Energy Act 2000
S.115**

MEMORANDUM

PETROLEUM PRODUCTION LICENCES

PPLs 6, 7, 8, 9, 10, 11, 12, 13, 14, 15, 16, 17, 18, 19, 20, 22, 23, 24, 25, 26, 27, 29, 30, 31, 32, 33, 35, 36, 37, 38, 39, 40, 41, 42, 43, 44, 45, 46, 47, 48, 51, 52, 53, 54, 55, 56, 57, 58, 59, 60, 61, 63, 64, 65, 66, 67, 68, 69, 70, 72, 73, 74, 75, 76, 77, 78, 79, 80, 81, 83, 84, 86, 87, 88, 89, 90, 91, 92, 94, 95, 98, 99, 100, 101, 102, 103, 104, 105, 106, 107, 108, 109, 110, 111, 113, 114, 115, 116, 117, 118, 119, 120, 121, 122, 123, 124, 125, 126, 127, 128, 129, 130, 131, 132, 133, 134, 135, 136, 137, 138, 139, 140, 143, 144, 145, 146, 147, 148, 149, 150, 151, 152, 153, 154, 155, 156, 158, 159, 160, 161, 162, 163, 164, 165, 166, 167, 172, 174, 175, 176, 177, 178, 179, 180, 182, 187, 189, 190, 193, 194, 195, 196, 201, 228, 229, 230, 231, 232, 233, 234, 235, 236, 237 and 238

ASSOCIATED ACTIVITIES LICENCES

AALs 258, 259 and 263

PIPELINE LICENCES

PLs 2, 5, 9, 15 and 20

1. Notation of change of company name:

From: Lattice Energy Limited
To: Beach Energy (Operations) Limited

is hereby entered on the public registers.



**BARRY A. GOLDSTEIN
Executive Director
Energy Resources Division
Department for Energy and Mining
Delegate of the Minister for Energy and Mining**

Date: 22 January 2020



Certificate of Registration on Change of Name

This is to certify that

LATTICE ENERGY LIMITED

Australian Company Number 007 845 338

did on the second day of December 2019 change its name to

BEACH ENERGY (OPERATIONS) LIMITED

Australian Company Number 007 845 338

The company is a public company.

The company is limited by shares.

The company is taken to be registered under the Corporations Act 2001 in South Australia and the date of commencement of registration is the ninth day of September, 1977.

Issued by the
Australian Securities and Investments Commission
on this second day of December 2019.

James Shipton
Chair

CERTIFICATE

Petroleum and Geothermal Energy Act 2000
S.115

MEMORANDUM

PETROLEUM PRODUCTION LICENCES

PPLs 6, 7, 8, 9, 10, 11, 12, 13, 14, 15, 16, 17, 18, 19, 20, 22, 23, 24, 25, 26, 27, 29, 30, 31, 32, 33, 35, 36, 37, 38, 39, 40, 41, 42, 43, 44, 45, 46, 47, 48, 51, 52, 53, 54, 55, 56, 57, 58, 59, 60, 61, 63, 64, 65, 66, 67, 68, 69, 70, 72, 73, 74, 75, 76, 77, 78, 79, 80, 81, 83, 84, 86, 87, 88, 89, 90, 91, 92, 94, 95, 98, 99, 100, 101, 102, 103, 104, 105, 106, 107, 108, 109, 110, 111, 113, 114, 115, 116, 117, 118, 119, 120, 121, 122, 123, 124, 125, 126, 127, 128, 129, 130, 131, 132, 133, 134, 135, 136, 137, 138, 139, 140, 143, 144, 145, 146, 147, 148, 149, 150, 151, 152, 153, 154, 155, 156, 158, 159, 160, 161, 162, 163, 164, 165, 166, 167, 172, 174, 175, 176, 177, 178, 179, 180, 182, 187, 189, 190, 193, 194, 195, 196, 201, 228, 229, 230, 231, 232, 233, 234, 235, 236, 237 and 238

PIPELINE LICENCES

PLs 5, 9 and 15

SA 2018-18 Notation of registrable dealing as evidenced by Deed of Variation dated 4 December 2015 between Santos Limited, Santos Petroleum Pty Ltd, Vamgas Pty Ltd, Santos (NARNL Cooper) Pty Ltd, Santos (BOL) Pty Ltd, Reef Oil Pty Ltd, Bridge Oil Developments Pty Limited, Basin Oil Pty Ltd, Alliance Petroleum Australia Pty Ltd, Origin Energy Resources Limited and Delhi Petroleum Pty Ltd is hereby entered on the public register.



BARRY A. GOLDSTEIN
Executive Director
Energy Resources Division
Department of the Premier and Cabinet
Delegate of the Minister for Energy and Mining

Date: 7 June 2018

Ref: 28/01/00045

Petroleum and Geothermal Energy Act 2000
S.115

MEMORANDUM

PETROLEUM RETENTION LICENCE
PRL 106

PETROLEUM EXPLORATION LICENCES
PELs 637 and 638

PETROLEUM PRODUCTION LICENCES
PPLs 6, 7, 8, 9, 10, 11, 12, 13, 14, 15, 16, 17, 18, 19, 20, 22, 23, 24, 25, 26, 27, 29, 30, 31, 32, 33, 35, 36, 37, 38, 39, 40, 41, 42, 43, 44, 45, 46, 47, 48, 51, 52, 53, 54, 55, 56, 57, 58, 59, 60, 61, 63, 64, 65, 66, 67, 68, 69, 70, 72, 73, 74, 75, 76, 77, 78, 79, 80, 81, 83, 84, 86, 87, 88, 89, 90, 91, 92, 94, 95, 98, 99, 100, 101, 102, 103, 104, 105, 106, 107, 108, 109, 110, 111, 113, 114, 115, 116, 117, 118, 119, 120, 121, 122, 123, 124, 125, 126, 127, 128, 129, 130, 131, 132, 133, 134, 135, 136, 137, 138, 139, 140, 143, 144, 145, 146, 147, 148, 149, 150, 151, 152, 153, 154, 155, 156, 158, 159, 160, 161, 162, 163, 164, 165, 166, 167, 172, 174, 175, 176, 177, 178, 179, 180, 182, 187, 189, 190, 193, 194, 195, 196, 201, 228, 229, 230, 231, 232, 233, 234, 235, 236, 237 and 238

PIPELINE LICENCES
PLs 2, 5, 9, 15 and 20

1. Notation of change of company name:

From: Origin Energy Resources Limited
To: Lattice Energy Limited

is hereby entered on the public registers.



BARRY A. GOLDSTEIN
Executive Director
Energy Resources Division
Department of the Premier and Cabinet
Delegate of the Minister for Mineral Resources and Energy

Date: 9 August 2017



Certificate of Registration on Change of Name

This is to certify that

ORIGIN ENERGY RESOURCES LIMITED

Australian Company Number 007 845 338

did on the twenty-ninth day of June 2017 change its name to

LATTICE ENERGY LIMITED

Australian Company Number 007 845 338

The company is a public company.

The company is limited by shares.

The company is taken to be registered under the Corporations Act 2001 in South Australia and the date of commencement of registration is the ninth day of September, 1977.

Issued by the
Australian Securities and Investments Commission
on this twenty-ninth day of June 2017.

A handwritten signature in black ink, appearing to read 'G. Medcraft'.

Greg Medcraft
Chairman

CERTIFICATE

**Petroleum and Geothermal Energy Act 2000
S.115**

MEMORANDUM

PETROLEUM PRODUCTION LICENCES

PPLs 6, 7, 8, 9, 10, 11, 12, 13, 14, 15, 16, 17, 18, 19, 20, 22, 23, 24, 25, 26, 27, 29, 30, 31, 32, 33, 35, 36, 37, 38, 39, 40, 41, 42, 43, 44, 45, 46, 47, 48, 51, 52, 53, 54, 55, 56, 57, 58, 59, 60, 61, 63, 64, 65, 66, 67, 68, 69, 70, 72, 73, 74, 75, 76, 77, 78, 79, 80, 81, 83, 84, 86, 87, 88, 89, 90, 91, 92, 94, 95, 98, 99, 100, 101, 102, 103, 104, 105, 106, 107, 108, 109, 110, 111, 113, 114, 115, 116, 117, 118, 119, 120, 121, 122, 123, 124, 125, 126, 127, 128, 129, 130, 131, 132, 133, 134, 135, 136, 137, 138, 139, 140, 143, 144, 145, 146, 147, 148, 149, 150, 151, 152, 153, 154, 155, 156, 158, 159, 160, 161, 162, 163, 164, 165, 166, 167, 172, 174, 175, 176, 177, 178, 179, 180, 182, 187, 189, 190, 193, 194, 195, 196, 201, 228, 229, 230, 231, 232, 233, 234, 235, 236, 237 and 238

SA 2012-42 Notation of registrable dealing as evidenced by Royalty Deed dated 19 January 2012 between Delhi Petroleum Pty Ltd and Esso Australia Resources Pty Ltd is hereby entered on the public register.



**BARRY A. GOLDSTEIN
Executive Director
Energy Resources Division
Department for Manufacturing, Innovation, Trade, Resources and Energy
Delegate of the Minister for Mineral Resources and Energy**

Date: 28 June 2012

Ref: various files

Petroleum and Geothermal Energy Act 2000
S.115

MEMORANDUM

PETROLEUM PRODUCTION LICENCES

PPLs 6, 7, 8, 9, 10, 11, 12, 13, 14, 15, 16, 17, 18, 19, 20, 22, 23, 24, 25, 26, 27, 29, 30, 31, 32, 33, 35, 36, 37, 38, 39, 40, 41, 42, 43, 44, 45, 46, 47, 48, 51, 52, 53, 54, 55, 56, 57, 58, 59, 60, 61, 63, 64, 65, 66, 67, 68, 69, 70, 72, 73, 74, 75, 76, 77, 78, 79, 80, 81, 83, 84, 86, 87, 88, 89, 90, 91, 92, 94, 95, 98, 99, 100, 101, 102, 103, 104, 105, 106, 107, 108, 109, 110, 111, 113, 114, 115, 116, 117, 118, 119, 120, 121, 122, 123, 124, 125, 126, 127, 128, 129, 130, 131, 132, 133, 134, 135, 136, 137, 138, 139, 140, 143, 144, 145, 146, 147, 148, 149, 150, 151, 152, 153, 154, 155, 156, 158, 159, 160, 161, 162, 163, 164, 165, 166, 167, 172, 174, 175, 176, 177, 178, 179, 180, 182, 187, 189, 190, 193, 194, 195, 196, 201, 228, 229, 230, 231, 232, 233, 234, 235, 236, 237 and 238

and

PIPELINE LICENCES

PLs 2, 5, 9 and 15

SA 2011-15 Notation of registrable dealing as evidenced by Delhi Fixed and Floating Charge and Mortgage of JV Assets dated 29 September 2010 between Delhi Petroleum Pty Limited and Westpac Banking Corporation is hereby entered on the public register.



BARRY A. GOLDSTEIN
Director Petroleum and Geothermal
Minerals and Energy Resources
Primary Industries and Resources SA
Delegate of the Minister for Mineral Resources
Development

Date: 15 February 2011

Petroleum Act 2000
S.115

MEMORANDUM

Petroleum Production Licences (PPLs) 6, 7, 8, 9, 10, 11, 12, 13, 14, 15, 16, 17, 18, 19, 20, 22, 23, 24, 25, 26, 27, 28, 29, 30, 31, 32, 33, 34, 35, 36, 37, 38, 39, 40, 41, 42, 43, 44, 45, 46, 47, 48, 49, 50, 51, 52, 53, 54, 55, 56, 57, 58, 59, 60, 61, 63, 64, 65, 66, 67, 68, 69, 70, 71, 72, 73, 74, 75, 76, 77, 78, 79, 80, 81, 82, 83, 84, 85, 86, 87, 88, 89, 90, 91, 92, 93, 94, 95, 96, 97, 98, 99, 100, 101, 102, 103, 104, 105, 106, 107, 108, 109, 110, 111, 112, 113, 114, 115, 116, 117, 118, 119, 120, 121, 122, 123, 124, 125, 126, 127, 128, 129, 130, 131, 132, 133, 134, 135, 136, 137, 138, 139, 140, 141, 142, 143, 144, 145, 146, 147, 148, 149, 150, 151, 152, 153, 154, 155, 156, 157, 158, 159, 160, 161, 162, 163, 164, 165, 166, 167, 169, 170, 171, 172, 173, 174, 175, 176, 177, 178, 179, 180, 181, 182, 183, 184, 185, 186, 187, 188, 189, 190, 191, 192, 193, 194, 195, 196, 197, 198, 199 and Pipeline Licence (PL) 2.

1. Notation of change of company name –

From: Santos (NARNL Cooper) NL
To: Santos (NARNL Cooper) Pty Ltd

is hereby entered on the public register of licences.



C. D. COCKSHELL
A/Director Petroleum and Geothermal
Minerals and Energy Resources
Primary Industries and Resources SA
Delegate of the Minister for Mineral Resources
Development

Date: 9 May 2006

File: 27/2/4

General Counsel
06 DEC 2005
Legal Services/
Group Secretariat

Form 242

Santos Limited Attn: Graham Bollenhagen
GPO Box 2455
Adelaide SA 5001

Remove this top section if desired before framing

Certificate of Registration on Change of Type and Conversion to a Proprietary Company



This is to certify that

SANTOS (NARNL COOPER) NL

Australian Company Number 004 761 255

on the first day of December 2005 converted to
a **company limited by shares**
and on the first day of December 2005 changed to
a **proprietary** company.

The name of the company is now

SANTOS (NARNL COOPER) PTY LTD

Australian Company Number 004 761 255

The company is taken to be registered under the Corporations
Act 2001 in Victoria and the date of commencement of
registration is the twenty-first day of February, 1969.

Issued by the
Australian Securities and Investments Commission
on this first day of December, 2005.

Jeffrey Lucy
Chairman

CERTIFICATE

Petroleum Act 2000
S.115

MEMORANDUM

Petroleum Production Licences (PPLs) 6, 7, 8, 9, 10, 11, 12, 13, 14, 15, 16, 17, 18, 19, 20, 22, 23, 24, 25, 26, 27, 28, 29, 30, 31, 32, 33, 34, 35, 36, 37, 38, 39, 40, 41, 42, 43, 44, 45, 46, 47, 48, 49, 50, 51, 52, 53, 54, 55, 56, 57, 58, 59, 60, 61, 63, 64, 65, 66, 67, 68, 69, 70, 71, 72, 73, 74, 75, 76, 77, 78, 79, 80, 81, 82, 83, 84, 85, 86, 87, 88, 89, 90, 91, 92, 93, 94, 95, 96, 97, 98, 99, 100, 101, 102, 103, 104, 105, 106, 107, 108, 109, 110, 111, 112, 113, 114, 115, 116, 117, 118, 119, 120, 121, 122, 123, 124, 125, 126, 127, 128, 129, 130, 131, 132, 133, 134, 135, 136, 137, 138, 139, 140, 141, 142, 143, 144, 145, 146, 147, 148, 149, 150, 151, 152, 153, 154, 155, 156, 157, 158, 159, 160, 161, 162, 163, 164, 165, 166, 167, 169, 170, 171, 172, 173, 174, 175, 176, 177, 178, 179, 180, 181, 182, 183, 184, 185, 186, 187, 188, 189, 190, 191, 192, 193, 194, 195, 196, 197, 198, 199 and Pipeline Licence (PL) 2.

1. Notation of change of company name –

From: Novus Australia Resources NL
To: Santos (NARNL Cooper) NL

is hereby entered on the public register of licences.



BARRY A. GOLDSTEIN
Director Petroleum
Minerals and Energy Resources
Primary Industries and Resources SA
Delegate of the Minister for Mineral Resources
Development

Date: 13 January 2006

File: 27/2/4

Santos Limited Attn: Graham Bollenhagen
GPO Box 2455
Adelaide SA 5001

Remove this top section if desired before framing

Certificate of Registration on Change of Name

This is to certify that

NOVUS AUSTRALIA RESOURCES NL

Australian Company Number 004 761 255

did on the twenty-ninth day of June 2005 change its name to

SANTOS (NARNL COOPER) NL

Australian Company Number 004 761 255

The company is a public company.

The company is a no liability company.

The company is taken to be registered under the Corporations Act 2001 in Victoria and the date of commencement of registration is the twenty-first day of February, 1969.

Issued by the
Australian Securities and Investments Commission
on this twenty-ninth day of June, 2005.



Jeffrey Lucy
Chairman



CERTIFICATE

Petroleum Act 2000
S.115

MEMORANDUM

PETROLEUM PRODUCTION LICENCES (PPLs) 6, 7, 8, 9, 10, 11, 12, 13, 14, 15, 16, 17, 18, 19, 20, 22, 23, 24, 25, 26, 27, 28, 29, 30, 31, 32, 33, 34, 35, 36, 37, 38, 39, 40, 41, 42, 43, 44, 45, 46, 47, 48, 49, 50, 51, 52, 53, 54, 55, 56, 57, 58, 59, 60, 61, 63, 64, 65, 66, 67, 68, 69, 70, 71, 72, 73, 74, 75, 76, 77, 78, 79, 80, 81, 82, 83, 84, 85, 86, 87, 88, 89, 90, 91, 92, 93, 94, 95, 96, 97, 98, 99, 100, 101, 102, 103, 104, 105, 106, 107, 108, 109, 110, 111, 113, 114, 115, 116, 117, 118, 119, 120, 121, 122, 123, 124, 125, 126, 127, 128, 129, 130, 131, 132, 133, 134, 135, 136, 137, 138, 139, 140, 141, 142, 143, 144, 145, 146, 147, 148, 149, 150, 151, 152, 153, 154, 155, 156, 157, 158, 159, 160, 161, 162, 163, 164, 165, 166, 167, 169, 170, 171, 172, 173, 174, 175, 176, 177, 178, 179, 180, 181, 182, 183, 184, 185, 186, 187, 188, 189, 190, 191, 192, 193, 194, 195, 196, 197, 198, 199

and

PIPELINE LICENCES (PLs) 2, 5, 9 and 15

1. Notation of receipt of Bank Guarantee dated 27 October 2005, is hereby entered on the commercial register.
2. Security is held to cover any event occurring in any licence operated by Santos Limited on behalf of the respective Cooper Basin Joint Ventures in South Australia.
3. Cash security held in respect of PPL 152 is hereby discharged to Santos Limited.
4. Bank Guarantees held in respect of the above referenced PLs and PPLs (excluding PPL 152) are hereby discharged to Santos Limited.

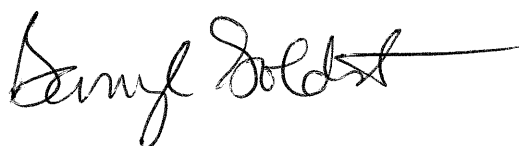

BARRY A GOLDSTEIN
Director Petroleum
Minerals and Energy Division
Primary Industries and Resources SA
Delegate of the Minister for Mineral Resources
Development

Date: 23 November 2005

Petroleum Act 2000

S.115

MEMORANDUM

PETROLEUM PRODUCTION LICENCES 6, 7, 8, 9, 10, 11, 12, 13, 14, 15, 16, 17, 18, 19, 20, 22, 23, 24, 25, 26, 27, 28, 29, 30, 31, 32, 33, 34, 35, 36, 37, 38, 39, 40, 41, 42, 43, 44, 45, 46, 47, 48, 49, 50, 51, 52, 53, 54, 55, 56, 57, 58, 59, 60, 61, 63, 64, 65, 66, 67, 68, 69, 70, 71, 72, 73, 74, 75, 76, 77, 78, 79, 80, 81, 82, 83, 84, 85, 86, 87, 88, 89, 90, 91, 92, 93, 94, 95, 96, 97, 98, 99, 100, 101, 102, 103, 104, 105, 106, 107, 108, 109, 110, 111, 113, 114, 115, 116, 117, 118, 119, 120, 121, 122, 123, 124, 125, 126, 127, 128, 129, 130, 131, 132, 133, 134, 135, 136, 137, 138, 139, 140, 141, 142, 143, 144, 145, 146, 147, 148, 149, 150, 151, 152, 153, 154, 155, 156, 157, 158, 159, 160, 161, 162, 163, 164, 165, 166, 167, 169, 170, 171, 172, 173, 174, 175, 176, 177, 178, 179, 180, 181, 182, 183, 184, 185, 186, 187, 188, 189, 190, 191, 192, 193, 194, 195, 196, 197, 198, 199

PIPELINE LICENCES 2, 5, 9 AND 15

1. Notation of registrable dealing as evidenced by the following document is hereby entered on the Public Register;

- SA 2004-44 DPPL Security dated 21 May 2004 between Delhi Petroleum Pty Ltd and Westpac Banking Corporation.



Paul Holloway

Leader of the Government in the Legislative Council
Minister for Industry, Trade and Regional Development
Minister for Mineral Resources Development
Minister for Small Business

Date: 23/7/04

Petroleum Act 2000

S.115(2)(e)

S.117(2)(b)

MEMORANDUM

PETROLEUM PRODUCTION LICENCES (PPLs) 6, 7, 8, 9, 10, 11, 12, 13, 14, 15, 16, 17, 18, 19, 20, 22, 23, 24, 25, 26, 27, 28, 29, 30, 31, 32, 33, 34, 35, 36, 37, 38, 39, 40, 41, 42, 43, 44, 45, 46, 47, 48, 49, 50, 51, 52, 53, 54, 55, 56, 57, 58, 59, 60, 61, 63, 64, 65, 66, 67, 68, 69, 70, 71, 72, 73, 74, 75, 76, 77, 78, 79, 80, 81, 82, 83, 84, 85, 86, 87, 88, 89, 90, 91, 92, 93, 94, 95, 96, 97, 98, 99, 100, 101, 102, 103, 104, 105, 106, 107, 108, 109, 110, 111, 112, 113, 114, 115, 116, 117, 118, 119, 120, 121, 122, 123, 124, 125, 126, 127, 128, 129, 130, 131, 132, 133, 134, 135, 136, 137, 138, 139, 140, 141, 142, 143, 144, 145, 146, 147, 148, 149, 150, 151, 152, 153, 154, 155, 156, 157, 158, 159, 160, 161, 162, 163, 164, 165, 166, 167, 169, 170, 171, 172, 173, 174, 175, 176, 177, 178, 179, 180, 181, 182, 183, 184, 185, 186, 187, 188, 189, 190, 191, 192, 193, 194, 195, 196, 197, 198 and 199

- 1 Pursuant to sections 115(2)(e) and 117(2)(b) of the *Petroleum Act 2000*, notation is hereby entered on the public and commercial register for each of the abovementioned PPLs, that the register created under the then *Petroleum Act 1940*, relative to Petroleum Exploration Licences 5 and 6, which expired on 27 February 1999, is adopted as part of the commercial register for each of the above said PPLs

Dated: 7 May 2004



T. AUST
A/Director Petroleum
Minerals and Energy Division
Primary Industries and Resources SA
Delegate of the Minister for Mineral
Resources Development

**Petroleum Act 2000
S.115**

MEMORANDUM

PETROLEUM PRODUCTION LICENCES

PPL's 6, 7, 8, 9, 10, 11, 12, 13, 14, 15, 16, 17, 18, 19, 20, 22, 23, 24, 25, 27, 28, 29, 30, 31, 32, 33, 34, 35, 36, 37, 38, 39, 40, 41, 42, 43, 44, 45, 46, 47, 48, 49, 50, 51, 52, 53, 54, 55, 56, 57, 58, 59, 60, 61, 63, 64, 65, 66, 67, 68, 69, 70, 71, 72, 73, 74, 75, 78, 79, 80, 81, 82, 83, 84, 85, 86, 87, 88, 89, 90, 91, 92, 93, 94, 95, 96, 97, 98, 99, 100, 101, 102, 103, 104, 105, 106, 107, 108, 109, 110, 111, 112, 113, 114, 115, 116, 117, 119, 120, 124, 126, 127, 128, 129, 130, 132, 133, 134, 135, 137, 138, 139, 140, 141, 143, 144, 145, 146, 148, 149, 150, 151, 153, 154, 155, 157, 159, 160, 161, 162, 163, 164, 165, 166, 169, 170, 171, 172, 173, 174, 175, 176, 177, 178, 179, 180, 181, 183, 184, 185, 186, 188, 189, 190, 192, 193, 195, 196, 198, 199;

And

**PIPELINE LICENCE
PL 2**

1. Notation of change of company name –

From: Basin Oil NL
To: Basin Oil Pty Ltd

is hereby entered on the public register of licences.



BARRY A GOLDSTEIN
Director Petroleum
Office of Minerals and Energy Resources
Delegate of the Minister for Mineral Resources
Development

Date: 15 October 2002

Form **242**

FREEHILL HOLLINGDALE & PAGE
AMP BUILDING
22nd Fl
140 ST Georges Terrace
PERTH WA 6000

Remove this top section if desired before framing

Certificate of Registration on Change of Type and Conversion to a Proprietary Company

This is to certify that

BASIN OIL N.L.

Australian Company Number 000 628 017

on the eighth day of June 2000 converted to
a company limited by shares
and on the eighth day of June 2000 changed
to a proprietary company.

The name of the company is now

BASIN OIL PTY LTD

Australian Company Number 000 628 017

The company is taken to be registered as a company
under the Corporations Law of New South Wales.

Issued by the
Australian Securities and Investments Commission
on this eighth day of June, 2000.



Alan Cameron
Chairman



CERTIFICATE

M E M O R A N D U M

PETROLEUM ACT 1940

SECTION 44

**PETROLEUM EXPLORATION LICENCES NOS. 27, 32, 57, 66 AND 72
PETROLEUM PRODUCTION LICENCES NOS. 6 TO 20, 22 TO 61 AND 63 TO 168
PIPELINE LICENCES 2, 5, 9 AND 10**

Receipt of the following document is hereby entered onto the Petroleum Register.

- Certificate of Registration on Change of Name dated 24 February 2000.
Boral Energy Resources Ltd is now known as Origin Energy Resources Ltd.



**J S ZABROWARNY
MANAGER PETROLEUM LICENSING AND ROYALTIES**

13 March 2000

24/02/00

14:37

+61 8 8223 4405

NO. 462 · 004

User: MARKK

Host: BETA1.oca.boral.com.au

Class: Job: MARKK_TRLRP

CLAYTON UTZ
1 O'Connell Street
SYDNEY NSW 2000

Remove this top section if desired before printing

Certificate of Registration on Change of Name

This is to certify that

BORAL ENERGY RESOURCES LIMITED

Australian Company Number 007 845 338

did on the twenty-fourth day of February 2000 change its name to

ORIGIN ENERGY RESOURCES LIMITED

Australian Company Number 007 845 338

The company is a public company.

The company is limited by shares.

The company is taken to be registered as a company
under the Corporations Law of South Australia.

Issued by the
Australian Securities and Investments Commission
on this twenty-fourth day of February, 2000.



Alan Cameron
Chairman



CERTIFICATE

MEMORANDUM

Section 44, Petroleum Act 1940

PETROLEUM PRODUCTION LICENCES 6 to 20,
22 to 61, 63 to 140, 142 to 167

PIPELINE LICENCE No. 2

Receipt of the following document is hereby entered onto the Petroleum Register.

- Certificate of Registration on Change of Name dated 6 October 1999.
Gulf (Aust) Resources NL is now known as Novus Australia Resources NL.



J S Zabrowarny
Manager, Petroleum Licensing and Royalties

10 December 1999

NOVUS PETROLEUM LIMITED
Level 9
321 Kent Street
SYDNEY NSW 2000

Remove this top section if desired before printing

Certificate of Registration on Change of Name



This is to certify that

GULF (AUST) RESOURCES N.L.

Australian Company Number 004 761 255

did on the sixth day of October 1999 change its name to

NOVUS AUSTRALIA RESOURCES NL

Australian Company Number 004 761 255

The company is a public company.

The company is a no liability company.

The company is taken to be registered as a company
under the Corporations Law of Victoria.

Issued by the
Australian Securities and Investments Commission
on this sixth day of October, 1999.

Alan Cameron
Chairman

CERTIFICATE

GRANT OF PETROLEUM PRODUCTION LICENCE

Department of Primary Industries and Resources, 10 June 1999

 NOTICE is hereby given that pursuant to delegated powers dated 20 November 1997, *Gazetted* 4 December 1997, page 1526, the undermentioned Petroleum Production Licence has been granted under the provisions of the Petroleum Act 1940.

D. R. MUTTON, Chief Executive, Delegate of the Minister for Primary Industries, Natural Resources and Regional Development

No. of Licence	Licencees	Locality	Date of Expiry	Area in km ²	Reference
139	Santos Ltd Delhi Petroleum Pty Ltd Boral Energy Resources Ltd Vangas Pty Ltd Gulf (Aust.) Resources NL Alliance Petroleum Australia Pty Ltd Reef Oil Pty Ltd Santos Petroleum Pty Ltd Bridge Oil Developments Pty Ltd Santos (BOL) Pty Ltd Basin Oil NL	Milluna Field in the Cooper Basin of South Australia	31 December 2019	15.73	SR.28.1.274

Description of the Area

All that part of the State of South Australia bounded as follows: commencing at a point being the intersection of latitude 28°19'10"S and longitude 140°28'20"E, thence east to longitude 149°29'50"E, south to latitude 28°19'30"S, east to longitude 140°30'00"E, south to latitude 28°20'25"S, west to longitude 140°29'45"E, south to latitude 28°20'35"S, west to longitude 140°29'05"E, south to latitude 28°20'40"S, west to longitude 140°28'50"E, south to latitude 28°20'50"S, west to longitude 140°28'30"E, south to latitude 28°21'40"S, west to longitude 140°26'40"E, north to latitude 28°20'10"S, east to longitude 140°27'50"E, north to latitude 28°20'05"S, east to longitude 140°28'00"E, north to latitude 28°19'55"S, east to longitude 140°28'10"E, north to latitude 28°19'30"S, west to longitude 140°28'20"E, and north to the point of commencement, all the within latitudes and longitudes being geodetic and expressed in terms of the Australian Geodetic Datum as defined on p. 4984 of *Commonwealth Gazette* number 84 dated 6 October 1966.

INFORMATION SA

Located on the Ground Floor, 77 Grenfell Street, Adelaide will be closed on **Friday, 25 June 1999** for annual stock-take.

ONLY Government Gazette sales for 24 June 1999 will be available from the Environment Shop, Ground Floor, 77 Grenfell Street, Adelaide from 9 a.m. to 5 p.m. on Friday, 25



SR 28/1/274

MEMORANDUM

PETROLEUM PRODUCTION LICENCE NO 139

1. This licence granted on 10/6/99 is hereby entered on the Petroleum Register.
2. A security in the form of a \$15,000 bank guarantee has been lodged with respect to this licence.
3. Interests in the licence are as follows:

	%
• Santos Ltd	40.70
• Delhi Petroleum Pty Ltd	20.21
• Boral Energy Resources Ltd	13.19
• Vamgas Pty Ltd	8.51
• Gulf (Aust) Resources NL	4.75
• Bridge Oil Developments Pty Ltd	3.99
• Alliance Petroleum Australia Pty Ltd	3.97
• Basin Oil NL	2.10
• Reef Oil Pty Ltd	1.97
• Santos Petroleum Ltd	0.40
• Santos (BOL) Pty Ltd	0.21

D R Mutton

CHIEF EXECUTIVE
DEPARTMENT OF PRIMARY
INDUSTRIES AND RESOURCES SA
Delegate of the Minister for Primary
Industries, Natural Resources and
Regional Development

**SOUTH AUSTRALIA
PETROLEUM ACT 1940**

and

COOPER BASIN (RATIFICATION) ACT 1975

PETROLEUM PRODUCTION LICENCE NO. 139

COMMISSIONER OF STATE TAXATION

S.A. STAMP DUTY

I, DENNIS RAY MUTTON, Chief Executive, Department of Primary Industries and Resources (CE) in the State of South Australia pursuant to the provisions of the Petroleum Act, 1940 and the Cooper Basin (Ratification) Act 1975 and all other enabling powers, for and on behalf of Robert Gerard Kerin, Minister for Primary Industries, Natural Resources and Regional Development ('Minister'), pursuant to delegation dated 20 November 1997, (refer Government Gazette dated 4 December 1997 page 1526), HEREBY GRANT JOINTLY to:

- **SANTOS LIMITED**, ACN 007 550 923 of Level 29, 91 King William Street, Adelaide, South Australia,
- **DELHI PETROLEUM PTY LTD**, ACN 007 854 686 of C/- Esso Australia Ltd, 12 Riverside Quay, Southbank, Victoria,
- **BORAL ENERGY RESOURCES LIMITED**, ACN 007 845 338 of 60 Hindmarsh Square, Adelaide, South Australia,
- **VAMGAS PTY LTD**, ACN 006 245 110 of Level 29, 91 King William Street, Adelaide, South Australia,
- **GULF (AUST) RESOURCES NL**, ACN 004 761 255 of 14th Floor, 216 St George's Terrace, Perth, Western Australia,
- **ALLIANCE PETROLEUM AUSTRALIA PTY LTD**, ACN 004 559 951 of Level 29, 91 King William Street, Adelaide, SA,
- **REEF OIL PTY LTD**, ACN 000 646 800 of Level 29, 91 King William Street, Adelaide, SA,
- **SANTOS PETROLEUM PTY LTD**, ACN 000 146 369 of Level 29, 91 King William Street, Adelaide, SA,
- **BRIDGE OIL DEVELOPMENTS PTY LTD**, ACN 001 152 049 of Level 29, 91 King William Street, Adelaide, SA,
- **SANTOS (BOL) PTY LTD**, ACN 000 670 575 of Level 29, 91 King William Street, Adelaide, SA,
- **BASIN OIL NL**, ACN 000 628 017 of Level 4, 828 Pacific Highway, Gordon, NSW.

a Petroleum Production Licence in respect of the area described hereunder:-

DESCRIPTION OF AREA

All that part of the State of South Australia bounded as follows:-

Commencing at a point being the intersection of latitude 28° 19' 10" S and longitude 140° 28' 20" E, thence east to longitude 149° 29' 50" E, south to latitude 28° 19' 30" S, east to longitude 140° 30' 00" E, south to latitude 28° 20' 25" S, west to longitude 140° 29' 45" E, south to latitude 28° 20' 35" S, west to longitude 140° 29' 05" E, south to latitude 28° 20' 40" S, west to longitude 140° 28' 50" E, south to latitude 28° 20' 50" S, west to longitude 140° 28' 30" E, south to latitude 28° 21' 40" S west to longitude 140° 26' 40" E, north to latitude 28° 20' 10" S, east to longitude 140° 27' 50" E, north to latitude 28° 20' 05" S, east to longitude 140° 28' 00" E, north to latitude 28° 19' 55" S, east to longitude 140° 28' 10" E, north to latitude 28° 19' 30" S, west to longitude 140° 28' 20" E,

and north to the point of commencement, all the within latitudes and longitudes being geodetic and expressed in terms of the Australian Geodetic Datum as defined on p. 4984 of Commonwealth Gazette number 84 dated October 6, 1966.

AREA 15.73 square kilometres approximately.

TERMS AND CONDITIONS

1. The term of this licence is twenty-one (21) years commencing on and inclusive of the first day of January 1999, with the right, subject to carrying out adequately the obligations of the licence, to renewal from time to time on the same terms and conditions for further terms of twenty-one (21) years.
2. The licensees hereby covenant with the Minister that they will make payment of the yearly rent provided under the Petroleum Act 1940 and of the royalty referred to in the Cooper Basin (Ratification) Act 1975 and will subject to the provisions of the Cooper Basin (Ratification) Act 1975 comply with the provisions of the Petroleum Act 1940 and with all Regulations for the time being in force under that Act and with any directions given by the Minister, the Chief Executive of Primary Industries and Resources or any other person pursuant to that Act or the said Regulations.
3. The Minister hereby gives and records his consent to the grant by the licensees of two sub-licences pursuant to the provisions of the Cooper Basin (Ratification) Act 1975 in the form of or to the effect set out in the Schedule hereto.

4. It is hereby acknowledged and agreed that the licensees own and hold the following undivided interests respectively in and under this licence:-

Santos	Forty point seven zero percent	(40.70%)
Delhi	Twenty point two one percent	(20.21%)
Boral Energy	Thirteen point one nine percent	(13.19%)
Vamgas	Eight point five one percent	(8.51%)
Gulf	Four point seven five percent	(4.75%)
Bridge Oil	Three point nine nine percent	(3.99%)
Alliance	Three point nine seven percent	(3.97%)
Basin	Two point one zero percent	(2.10%)
Reef	One point nine seven percent	(1.97%)
Santos Petroleum	Zero point four zero percent	(0.40%)
Santos (BOL)	Zero point two one percent	(0.21%)

PROVIDED THAT nothing in this Clause contained shall in any way affect or derogate from the rights, duties and liabilities of the licensees (as determined pursuant to the Indenture as defined in the Cooper Basin (Ratification) Act 1975 and the Petroleum Act 1940) to the Minister under this licence **AND PROVIDED FURTHER THAT** as between the licensees the undivided interests so owned and held by the licensees shall be subject to the provisions of a Joint Operating Agreement dated the 17th. day of October 1973 to which the licensees are parties and as the same has been amended and as may hereafter be amended from time to time.

Signed by the Chief Executive,
Department of Primary Industries and
Resources at Adelaide

this 10th day of June 1999

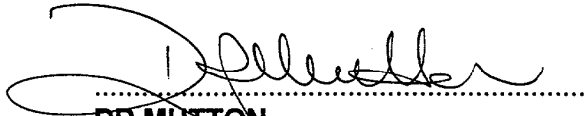

DR MUTTON
CHIEF EXECUTIVE
Department of Primary Industries and
Resources SA
Delegate of the Minister for Primary
Industries, Natural Resources
and Regional Development

SIGNED, SEALED AND DELIVERED)
by the said LICENSEES at Adelaide)
this 1st day of June 1999)

Executed on behalf of SANTOS LIMITED, ALLIANCE)
PETROLEUM AUSTRALIA PTY LTD, REEF OIL)
PTY LTD, SANTOS (BOL) PTY LTD, BRIDGE OIL)
DEVELOPMENTS PTY LTD, SANTOS PETROLEUM)
PTY LTD and VAMGAS PTY LTD, respectively by being)
SIGNED, SEALED AND DELIVERED by its duly)
authorised Attorney under Power of Attorney who)
hereby states that he has received no notice of)
revocation of the Power of Attorney affecting such)
appointment, in the presence of:)

Handwritten signature

Handwritten signature

(Witness)

~~SIGNED, SEALED AND DELIVERED~~)
for and on behalf of DELHI PETROLEUM)
PTY LTD by IAN WILLIAM ANGUS)
its duly authorised Attorney under Power of)
Attorney dated the 12th day of February)
1993, who hereby states that he has no)
notice of revocation of the said Power of)
Attorney at the time of executing this)
instrument in the presence of:)

Handwritten signature

(Witness)

Handwritten signature

Delhi Petroleum Pty Ltd
by its Attorney
IAN WILLIAM ANGUS

THE COMMON SEAL of BORAL ENERGY)
RESOURCES LIMITED was hereunto)
affixed in the presence of:)

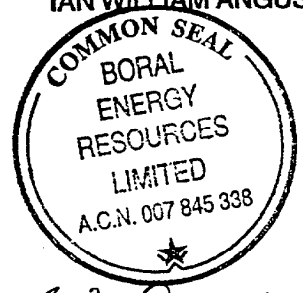

Handwritten signature
DIRECTOR
ROBERT JAN WILLIAMS

(Director)

Handwritten signature

(Secretary)

THE COMMON SEAL OF GULF (AUST)
RESOURCES NL was hereunto affixed in
the presence of:

David R. Whitby
.....
(Director)
DAVID R. WHITBY
MANAGING DIRECTOR

Shona S Taylor
.....
Shona S Taylor CA
Finance Director



THE COMMON SEAL of BASIN OIL
NL was hereunto affixed in the presence of:

D. Russo
.....
(Director)



Valerie Casey
.....
(Secretary)

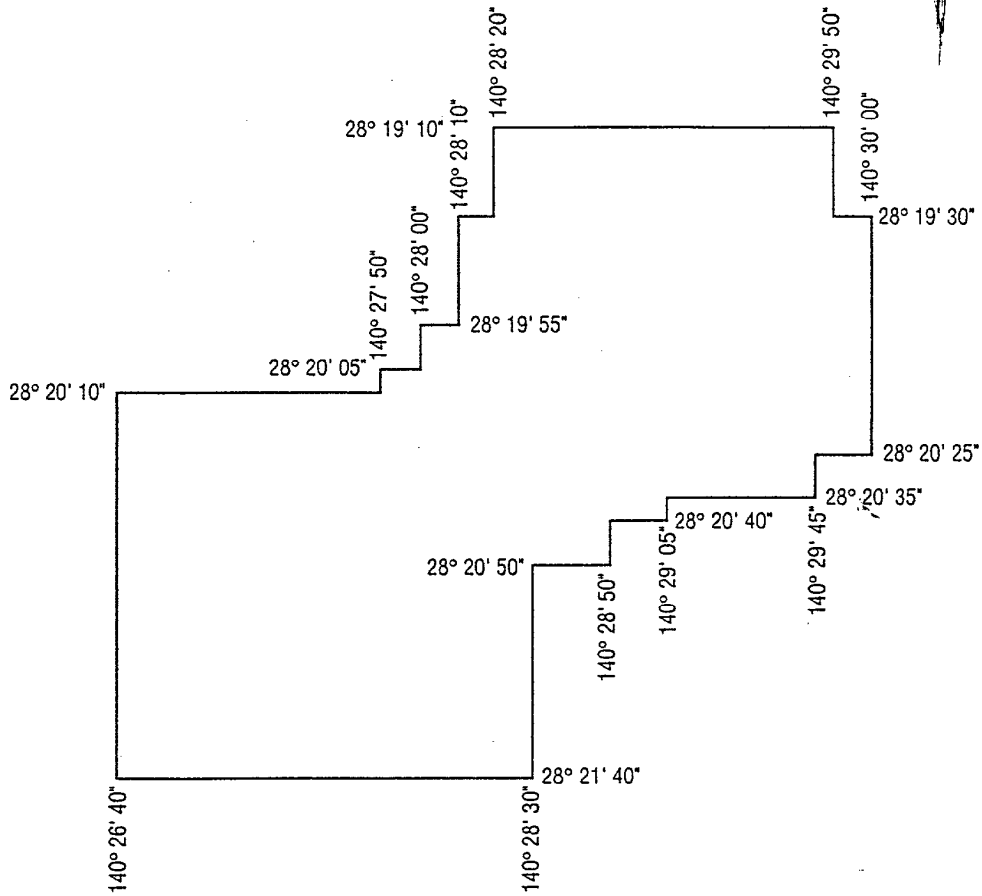

SCALE 1 : 50 000

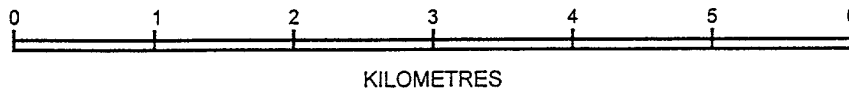

All the within latitudes and longitudes are geodetic and expressed in terms of the Australian Geodetic Datum as defined on page 4984 of Commonwealth Gazette number 84 dated 6 October 1966, except those latitudes and longitudes underlined which are expressed in terms of Clarke 1858 Spheroid (Transverse Mercator Projection)

SANTOS LTD. DELHI PETROLEUM PTY. LTD. BORAL ENERGY RESOURCES LTD.
 VAMGAS PTY. LTD. GULF (AUST) RESOURCES N.L. BASIN OIL N.L. REEF OIL PTY. LTD.
 ALLIANCE PETROLEUM AUSTRALIA PTY. LTD. BRIDGE OIL DEVELOPMENTS PTY. LTD.
 SANTOS PETROLEUM PTY. LTD. SANTOS (BOL) PTY. LTD.

MILLUNA FIELD

PETROLEUM PRODUCTION LICENCE NO. 139

MINES and ENERGY
RESOURCES SOUTH AUSTRALIA



SR 28/1/274

AREA: 15.73 sq km (approx)

THE SCHEDULE HEREINBEFORE REFERRED TO



THIS DEED OF SUB-LICENCE made the day of 199

BETWEEN:

ALLIANCE PETROLEUM AUSTRALIA PTY. LTD. A.C.N. 004 559 951 whose registered office is situated at Level 29, Santos House, 91 King William Street, Adelaide in the State of South Australia (hereinafter sometimes called "Alliance" which expression where the context requires or permits shall include its successors and assigns);

AND

BASIN OIL N.L. A.C.N. 000 628 017 whose registered office is situated at Level 4, 828 Pacific Highway, Gordon in the State of New South Wales (hereinafter sometimes called "Basin" which expression where the context requires or permits shall include its successors and assigns);

AND

BORAL ENERGY RESOURCES LIMITED A.C.N. 007 845 338 whose registered office is situated at 60 Hindmarsh Square, Adelaide in the State of South Australia (hereinafter sometimes called "Boral" which expression where the context requires or permits shall include its successors and assigns);

AND

BRIDGE OIL DEVELOPMENTS PTY. LIMITED A.C.N. 001 152 049 whose registered office is situated at Level 29, Santos House, 91 King William Street, Adelaide in the State of South Australia (hereinafter sometimes called "BOD" which expression where the context requires or permits shall include its successors and assigns);



AND

DELHI PETROLEUM PTY. LTD. A.C.N. 007 854 686 whose registered office is situated at 12 Riverside Quay, Southbank in the State of Victoria (hereinafter sometimes called "Delhi" which expression where the context requires or permits shall include its successors and assigns);

AND

GULF (AUST) RESOURCES N.L. A.C.N. 004 761 255 whose registered office is situated at Level 14, London House, 216 St. Georges Terrace, Perth, in the State of Western Australia (hereinafter sometimes called "Gulf" which expression where the context requires or permits shall include its successors and assigns);

AND

REEF OIL PTY. LTD. A.C.N. 000 646 800 whose registered office is situated at Level 29, Santos House, 91 King William Street, Adelaide in the State of South Australia (hereinafter sometimes called "Reef" which expression where the context requires or permits shall include its successors and assigns);

AND

SANTOS LIMITED A.C.N. 007 550 923 whose registered office is situated at Level 29, Santos House, 91 King William Street, Adelaide in the State of South Australia (hereinafter sometimes called "Santos" which expression where the context requires or permits shall include its successors and assigns);



AND

SANTOS (BOL) PTY. LTD. A.C.N. 000 670 575 whose registered office is situated at Level 29, Santos House, 91 King William Street, Adelaide in the State of South Australia (hereinafter sometimes called "Santos (BOL)" which expression where the context requires or permits shall include its successors and assigns);

AND

SANTOS PETROLEUM PTY. LTD. A.C.N. 000 146 369 whose registered office is situated at Level 29, Santos House, 91 King William Street, Adelaide in the State of South Australia (hereinafter sometimes called "Santos Petroleum" which expression where the context requires or permits shall include its successors and assigns);

AND

VAMGAS PTY. LTD. A.C.N. 006 245 110 whose registered office is situated at Level 29, Santos House, 91 King William Street, Adelaide in the State of South Australia (hereinafter sometimes called "Vamgas" which expression where the context requires or permits shall include its successors and assigns);

the said companies being hereinafter collectively called "the Licensors" which expression where the context requires or permits shall include their respective successors and assigns);

OF THE ONE PART

AND



the said companies being hereinafter collectively called "the Licensees" which expression where the context requires or permits shall include their respective successors and assigns);

OF THE OTHER PART

WHEREAS:-

- A. The Licensors are the holders of Petroleum Production Licence No. [DATE OF LICENCE] granted by the Minister for Primary Industries and Resources of the State of South Australia pursuant to the powers in the *Petroleum Act 1940* and the *Cooper Basin (Ratification) Act 1975* over certain land in the State of South Australia as more particularly described in the said Petroleum Production Licence No. [] .
- B. The Licensees are parties to an agreement made as of the 1st day of January 1975 known as the South Australian Cooper Basin Unit Agreement (hereinafter and as the same has been and may hereafter be amended from time to time referred to as "the Unit Agreement") relating inter alia to the development and production of petroleum from that sub-surface portion of the area comprised in the said Petroleum Production Licence No. [] as the same is more particularly described in the Schedule hereto.
- C. The Licensors with the consent of the Minister for Primary Industries and Resources of the State of South Australia have agreed to grant and the Licensees have agreed to accept a sub-licence to exercise the rights specified in Clause 1 hereof upon the conditions specified in Clauses 2, 3, 4 and 5 hereof.

NOW THIS DEED WITNESSETH AS FOLLOWS:-

1. The Licensors with the consent of the Minister for Primary Industries and Resources of the State of South Australia hereby grant to each of the Licensees severally the

exclusive right for a period of twenty-one (21) years commencing and inclusive of the First day of January [YEAR] (with the right of-renewal hereinafter contained) subject to the provisions of this Deed of Sub-Licence to:-

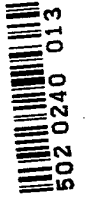

- (a) conduct operations for the appraisal and production of petroleum from such sub-surface portion of the area comprised in the said Petroleum Production Licence No. [] as is more particularly described in the Schedule hereto (hereinafter referred to as "the Unitized Zone") and subject to Clause 2 hereof to own all petroleum extracted or released therefrom; and
 - (b) construct and maintain upon the land comprised in the said Petroleum Production Licence No. [] all such facilities as the Licensors are entitled to construct and maintain thereon pursuant to Section 33 of the *Petroleum Act 1940* or the *Cooper Basin (Ratification) Act 1975* (or both) of the State of South Australia and as are necessary from time to time for the full enjoyment of the rights granted pursuant to Clause 1(a) hereof.
2. Each of the Licensees hereby expressly acknowledges, covenants and agrees with the Licensors and with each of the other Licensees that in the exercise of exclusive rights granted pursuant to Clause 1 hereof each Licensee shall at all times act subject to and in accordance with the provisions of the Unit Agreement (and in particular to the provisions of Clause 13.01 thereof which refers to an overriding royalty in favour of Santos) and that such rights shall entitle each Licensee to extract or release from the Unitized Zone so much of the petroleum within the Unitized Zone as such Licensee is entitled to from time to time in accordance with its Gas Unit Participation, Ethane Unit Participation, Propane Unit Participation, Butane Unit Participation, Condensate Unit Participation, Crude Oil Unit Participation and its Additional Plant Products Unit Participation or Participations in accordance with the provisions of the Unit Agreement.
 3. The Licensees hereby jointly and severally covenant with the Licensors that they will make payment in accordance with the Unit Agreement, as amended, of the royalty

referred to in the *Cooper Basin (Ratification) Act 1975* in respect to the production referred to in Clause 2 hereof and subject to the provisions of the *Cooper Basin (Ratification) Act 1975* make payment in accordance with the Unit Agreement of the yearly rent provided under the said *Petroleum Act 1940* and will subject as aforesaid comply with the provisions of the said *Petroleum Act 1940* and with all Regulations for the time being in force under that Act and with any directions given by the Minister, the Director-Petroleum Group for Primary Industries and Resources or any other person pursuant to that Act or the said Regulations and the Licensees hereby further jointly and severally covenant with the Licensors not to do any act or thing or make any omission which would cause the Licensors to be in breach or default of the provisions of the said Petroleum Production Licence No. [] or of the provisions of the said *Petroleum Act 1940* or of any Regulation for the time being in force under that Act or with any direction given by the Minister, the Director-Petroleum Group for Primary Industries and Resources or any other person pursuant to that Act or the said Regulations.

4. Subject to the due compliance by the Licensees with their obligations under this Deed of Sub-Licence the Licensors hereby covenant with the Licensees:-
- (a) to perform the covenants and obligations on the part of the Licensors contained in the said Petroleum Production Licence No. [];
 - (b) that for such period as the same is required for the purpose of the Unit Agreement, to exercise their rights of renewal pertaining to the said Petroleum Production Licence No. []; and
 - (c) to renew the provisions of this Deed of Sub-Licence on the same terms and conditions during any renewed term of the said Petroleum Production Licence No. [] for such period as aforesaid.
5. The rights of the Licensees or any of them granted pursuant to the foregoing provisions of this Deed of Sub-Licence shall not be sold assigned transferred leased sub-let mortgaged pledged charged encumbered or otherwise disposed of other than subject to



and in accordance with the provisions of Article XV of the Unit Agreement and subject to Section 42 of the said *Petroleum Act 1940* and Clause 14.2 of the Indenture as defined in the *Cooper Basin (Ratification) Act 1975*.





THE SCHEDULE
("Description of Unitized Zones")



IN WITNESS WHEREOF the Parties hereto sign seal and deliver the foregoing presents and have hereunto set their respective hands and seals as of the day and year first above written.

Executed on behalf of)
ALLIANCE PETROLEUM AUSTRALIA)
PTY. LTD., BRIDGE OIL)
DEVELOPMENTS PTY. LIMITED, REEF)
OIL PTY. LTD., SANTOS LIMITED,)
SANTOS (BOL) PTY. LTD., SANTOS)
PETROLEUM PTY. LTD. and VAMGAS)
PTY. LTD., respectively by being SIGNED)
SEALED AND DELIVERED by its duly)
authorised Attorney under Power of Attorney)
who hereby states that he has received no)
notice of revocation of the Power of Attorney)
effecting such appointment, in the presence of:)

.....
(Witness)

.....
(Attorney)

THE COMMON SEAL of)
BASIN OIL N.L. was)
hereunto affixed in the presence of:)

.....
Secretary

.....
Director

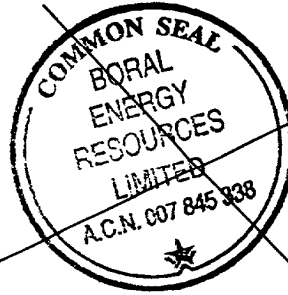

THE COMMON SEAL of
BORAL ENERGY RESOURCES
LIMITED was hereunto affixed in the
presence of:)
)
)
)

.....
Secretary

.....
Director
DIRECTOR
ROBERT JAN WILLINK

EXECUTED for and on behalf of)
DELHI PETROLEUM PTY. LTD.)
by IAN WILLIAM ANGUS)
its duly authorised Attorney in the presence of:)
)

.....
Witness

.....
Delhi Petroleum Pty. Ltd.
by its Attorney



THE COMMON SEAL of)
GULF (AUST) RESOURCES N.L.)
was hereunto affixed in the presence of:)

.....
Secretary

.....
Director

In accordance with Section 117 of the *Petroleum Act 2000* (Act) this document forms part of 'The Commercial Register'.

Section 118 of the Act provides for the following:

Authority to search register

(1) A person is entitled to have access to the material included in the commercial register, on payment of the prescribed inspection fee, if the access is authorised by—

- (a) a person who has a legal or equitable interest in the relevant licence or registered dealing; or
- (b) (b) the Minister.

(2) The Minister must not authorise access under subsection (1)(b) unless the Minister has consulted with the licensee to whom the material relates and is satisfied that access should be authorised in the public interest.

FOR FURTHER INFORMATION PLEASE CONTACT:

Department of State Development
Energy Resources Division
GPO Box 320,
Adelaide SA 5001
(08) 8463 3204